

**Features**

- XuanTie C906 RISC-V CPU
- HiFi4 DSP
- Memories
  - DDR2/DDR3 SDRAM
  - SD3.0/SDIO3.0/eMMC5.0
- Video Engine
  - H.265/H.264/MPEG-1/2/4/JPEG/VC1 decoding, up to 4K
  - JPEG/MJPEG encoding, up to 1080p@60fps
- Video and Graphics
  - Allwinner SmartColor2.0 post processing for an excellent display experience
  - Supports de-interlace (DI) up to 1080p@60fps
  - Supports Graphic 2D (G2D) hardware accelerator including rotate, mixer, LBC decompression functions
- Video Output
  - RGB interface up to 1920 x 1080@60fps
  - Dual link LVDS interface up to 1920 x 1080@60fps
  - 4-lane MIPI DSI up to 1920 x 1200@60fps
  - HDMI TX interface up to 4K@30fps
  - CVBS OUT interface, supporting NTSC and PAL format
- Video Input
  - 8-bit parallel CSI interface
  - CVBS IN interface, supporting NTSC and PAL format
- Analog Audio Codec
  - 2 DACs and 3 ADCs
  - Analog audio interfaces: LINEOUTLP/N, LINEOUTRP/N, HPOUTL/R, MICIN1P/1N, MICIN2P/2N, MICIN3P/3N, LINEINL/R, FMINL/R
- Three I2S/PCM external interfaces (I2S0, I2S1, I2S2)
- Maximum 8 digital PDM microphones (DMIC)
- OWA TX and OWA RX, compliance with S/PDIF interface
- Security System
  - AES, DES, 3DES, RSA, MD5, SHA, HMAC
  - Integrated 2 Kbits OTP storage space
- External Peripherals
  - USB 2.0 DRD (USB0) and USB 2.0 HOST (USB1)
  - 10/100/1000 Mbps Ethernet port with RGMII and RMII interfaces
  - Up to 6 UART controllers (UART0, UART1, UART2, UART3, UART4, UART5)
  - Up to 2 SPI controllers (SPI0, SPI1)
  - Up to 4 TWI controllers (TWI0, TWI1, TWI2, TWI3)
  - CIR RX and CIR TX
  - 8 independent PWM channels (PWM0 to PWM7)
  - 2-ch GPADC
  - 4-ch TPADC
  - 1-ch LRADC
  - LEDC
- Package
  - LFBGA 337 balls, 13 mm x 13 mm

## Revision History

Revision	Date	Author	Description
0.1	March 02, 2021	AWAXXX	Draft version

Draft Version  
ALLWINER

# Contents

The RISC-V Multi-Media Decoding Platform SoC .....	i
Revision History.....	i
Contents .....	ii
Figures.....	vi
Tables .....	viii
About This Documentation .....	1
1 Overview .....	3
2 Features.....	4
2.1 CPU Architecture.....	4
2.2 DSP Architecture .....	4
2.3 Memory Subsystem.....	4
2.3.1 Boot ROM (BROM) .....	4
2.3.2 SDRAM .....	4
2.3.3 SMHC.....	4
2.4 Video Engine .....	5
2.5 Video and Graphics .....	5
2.5.1 Display Engine (DE).....	5
2.5.2 De-interlacer (DI).....	6
2.5.3 Graphic 2D (G2D) .....	6
2.6 Video Output .....	7
2.6.1 RGB and LVDS LCD.....	7
2.6.2 MIPI DSI .....	7
2.6.3 HDMI .....	7
2.6.4 CVBS OUT .....	8
2.7 Video Input .....	8
2.7.1 Parallel CSI.....	8
2.7.2 CVBS IN.....	8
2.8 System Peripherals .....	9
2.8.1 Timer.....	9
2.8.2 High Speed Timer (HSTimer).....	9

2.8.3	Platform-Level Interrupt Controller (PLIC) .....	9
2.8.4	DMAC .....	9
2.8.5	Clock Controller Unit (CCU) .....	10
2.8.6	Thermal Sensor Controller (THS).....	10
2.8.7	LDO Power .....	10
2.8.8	RTC .....	10
2.8.9	Reset.....	11
2.9	Audio Subsystem .....	11
2.9.1	Audio Codec .....	11
2.9.2	I2S/PCM.....	12
2.9.3	DMIC.....	12
2.9.4	One Wire Audio (OWA) .....	12
2.10	External Peripherals .....	14
2.10.1	USB DRD .....	14
2.10.2	USB HOST .....	14
2.10.3	EMAC.....	15
2.10.4	UART.....	15
2.10.5	SPI and SPI_DBI .....	16
2.10.6	Two Wire Interface (TWI) .....	17
2.10.7	CIR Receiver (CIR_RX).....	17
2.10.8	CIR Transmitter (CIR_TX) .....	17
2.10.9	PWM.....	17
2.10.10	General Purpose ADC (GPADC) .....	18
2.10.11	Touch Panel ADC (TPADC) .....	18
2.10.12	Low Rate ADC (LRADC).....	19
2.10.13	LEDC .....	19
2.11	Package .....	19
3	Block Diagram .....	20
4	Pin Description .....	22
4.1	Pin Quantity .....	22
4.2	Pin Characteristics.....	22
4.3	GPIO Multiplex Function .....	35
4.4	Detailed Signal Description .....	39
5	Electrical Characteristics .....	52

5.1	Parameter Conditions .....	52
5.1.1	Minimum and Maximum Values .....	52
5.1.2	Typical Values .....	52
5.1.3	Temperature Definitions .....	52
5.2	Absolute Maximum Ratings .....	52
5.3	Recommended Operating Conditions .....	54
5.4	Power Consumption Parameters .....	56
5.5	DC Electrical Characteristics .....	58
5.6	SDIO Electrical Characteristics.....	58
5.7	GPADC Electrical Characteristics .....	60
5.8	LRADC Electrical Characteristics.....	60
5.9	Audio Codec Electrical Characteristics .....	61
5.10	External Clock Source Characteristics .....	63
5.10.1	High-speed Crystal/Ceramic Resonator Characteristics.....	63
5.10.2	Low-speed Crystal/Ceramic Resonator Characteristics.....	64
5.11	Internal Reset Electrical Characteristics .....	65
5.12	External Memory Electrical Characteristics .....	65
5.12.1	SMHC AC Electrical Characteristics .....	65
5.13	External Peripheral Electrical Characteristics.....	73
5.13.1	EMAC AC Electrical Characteristics.....	73
5.13.2	SPI AC Electrical Characteristics .....	75
5.13.3	UART AC Electrical Characteristics .....	76
5.13.4	TWI AC Electrical Characteristics.....	78
5.13.5	I2S/PCM AC Electrical Characteristics .....	79
5.13.6	DMIC AC Electrical Characteristics .....	80
5.13.7	OWA AC Electrical Characteristics .....	81
5.13.8	CIR_RX AC Electrical Characteristics.....	81
5.14	Power-On and Power-Off Sequence.....	82
5.14.1	Power-On Sequence .....	82
5.14.2	Power-Off Sequence.....	82
6	Package Thermal Characteristics.....	84
7	Pin Assignment.....	85
7.1	Pin Map .....	85
7.2	Package Dimension .....	86

8	Carrier, Storage and Baking Information .....	87
8.1	Carrier .....	87
8.1.1	Matrix Tray Information .....	87
8.2	Storage .....	88
8.2.1	Moisture Sensitivity Level (MSL) .....	88
8.2.2	Bagged Storage Conditions .....	89
8.2.3	Out-of-bag Duration .....	89
8.3	Baking .....	89
9	Reflow Profile .....	91
10	FT/QA/QC Test .....	93
10.1	FT Test .....	93
10.2	QA Test .....	93
10.3	QC Test .....	93
11	Part Marking .....	94



## Figures

Figure 3-1 D1 System Block Diagram .....	20
Figure 3-2 D1 Multi-Media Decoding Platform Solution .....	21
Figure 5-1 SDIO Voltage Waveform .....	59
Figure 5-2 SMHC HS-SDR Mode Output Timing Diagram .....	66
Figure 5-3 SMHC HS-SDR Mode Input Timing Diagram .....	66
Figure 5-4 SMHC HS-DDR Mode Output Timing Diagram.....	67
Figure 5-5 SMHC HS-DDR Mode Input Timing Diagram.....	68
Figure 5-6 SMHC HS200 Mode Output Timing Diagram.....	69
Figure 5-7 SMHC HS200 Mode Input Timing Diagram.....	70
Figure 5-8 SMHC HS400 Data Output Timing Diagram.....	71
Figure 5-9 SMHC HS400 Data Input Timing Diagram.....	72
Figure 5-10 RGMII Interface Transmit Timing.....	73
Figure 5-11 RGMII Interface Receive Timing.....	74
Figure 5-12 RMII Interface Transmit Timing .....	74
Figure 5-13 RMII Interface Receive Timing.....	75
Figure 5-14 SPI Writing Timing.....	75
Figure 5-15 SPI Reading Timing.....	76
Figure 5-16 UART RX Timing .....	76
Figure 5-17 UART nCTS Timing.....	77
Figure 5-18 UART nRTS Timing.....	77
Figure 5-19 TWI Timing.....	78
Figure 5-20 I2S/PCM Timing in Master Mode.....	79
Figure 5-21 I2S/PCM Timing in Slave Mode.....	79
Figure 5-22 DMIC Timing .....	80
Figure 5-23 OWA Timing.....	81
Figure 5-24 CIR_RX Timing.....	81
Figure 5-25 Power-On Timing .....	82
Figure 5-26 Power-Off Timing.....	83
Figure 7-1 D1 Pin Map.....	85
Figure 7-2 D1 Package Dimension.....	86

Figure 8-1 D1 Tray Dimension Drawing .....88

Figure 9-1 Lead-free Reflow Profile .....91

Figure 9-2 Measuring the Reflow Soldering Process .....92

Figure 11-1 D1 Marking.....94





## Tables

Table 4-1 D1 Pin Quantity .....	22
Table 4-2 Pin Characteristics.....	23
Table 4-3 GPIO Multiplex Function .....	35
Table 4-4 Detailed Signal Description .....	39
Table 5-1 Absolute Maximum Ratings .....	53
Table 5-2 Recommended Operating Conditions.....	54
Table 5-3 Power Consumption Parameters .....	56
Table 5-4 DC Electrical Characteristics.....	58
Table 5-5 3.3 V SDIO Electrical Parameters .....	59
Table 5-6 1.8 V SDIO Electrical Parameters .....	59
Table 5-7 GPADC Electrical Characteristics .....	60
Table 5-8 LRADC Electrical Characteristics.....	60
Table 5-9 Audio Codec Typical Performance Parameters.....	61
Table 5-10 High-speed 24 MHz Crystal Circuit Characteristics .....	63
Table 5-11 Crystal Circuit Parameters.....	63
Table 5-12 Low-speed 32.768 kHz Crystal Circuit Characteristics .....	64
Table 5-13 Internal Reset Electrical Characteristics.....	65
Table 5-14 SMHC HS-SDR Mode Output Timing Constants .....	66
Table 5-15 SMHC HS-SDR Mode Input Timing Constants .....	66
Table 5-16 SMHC HS-DDR Mode Output Timing Constants .....	67
Table 5-17 SMHC HS-DDR Mode Input Timing Constants .....	68
Table 5-18 SMHC HS200 Mode Output Timing Constants.....	69
Table 5-19 SMHC HS200 Mode Input Timing Constants.....	70
Table 5-20 SMHC HS400 Output Timing Parameters.....	71
Table 5-21 SMHC HS400 Data Input Timing Parameter.....	72
Table 5-22 RGMII Transmit Timing Constants .....	73
Table 5-23 RGMII Receive Timing Constants .....	74
Table 5-24 RMII Transmit Timing Constants .....	75
Table 5-25 RMII Receive Timing Constants.....	75
Table 5-26 SPI Timing Constants.....	76

Table 5-27 UART Timing Constants.....	77
Table 5-28 TWI Timing Parameters.....	78
Table 5-29 I2S/PCM Timing Constants in Master Mode.....	79
Table 5-30 I2S/PCM Timing Constants in Slave Mode.....	80
Table 5-31 DMIC Timing Constants.....	80
Table 5-32 OWA Timing Constants.....	81
Table 5-33 CIR_RX Timing Constants.....	81
Table 6-1 D1 Package Thermal Characteristics.....	84
Table 8-1 Matrix Tray Carrier Information.....	87
Table 8-2 D1 Packing Quantity Information.....	87
Table 8-3 MSL Summary.....	88
Table 8-4 Bagged Storage Conditions.....	89
Table 8-5 Out-of-bag Duration.....	89
Table 9-1 Lead-free Reflow Profile Conditions.....	91
Table 11-1 D1 Marking Definitions.....	94



# About This Documentation

## Purpose

The documentation describes features of each module, pin/signal characteristics, current consumption, interface timing, thermal and package, and part reliability of the D1 processor. For details about register descriptions of each module, see the [D1\\_User\\_Manual](#).

## Intended Audience



The document is intended for:

- Hardware designers and maintenance personnel for electronics
- Sales personnel for electronic parts and components

## Conventions

### Symbol Conventions

The symbols that may be found in this document are defined as follows.

Symbol	Description
 <b>WARNING</b>	Indicates potential risk of injury or death exists if the instructions are not obeyed.
 <b>CAUTION</b>	Indicates potential risk of equipment damage, data loss, performance degradation, or unexpected results exists if the instructions are not obeyed.
 <b>NOTE</b>	Provides additional information to emphasize or supplement important points of the main text.

### Table Content Conventions

The table content conventions that may be found in this document are defined as follows.

Symbol	Description
-	The cell is blank.

### Numerical Conventions

The expressions of data capacity, frequency, and data rate are described as follows.

Type	Symbol	Value
Data capacity	1K	1024
	1M	1,048,576
	1G	1,073,741,824
Frequency, data rate	1k	1000
	1M	1,000,000
	1G	1,000,000,000

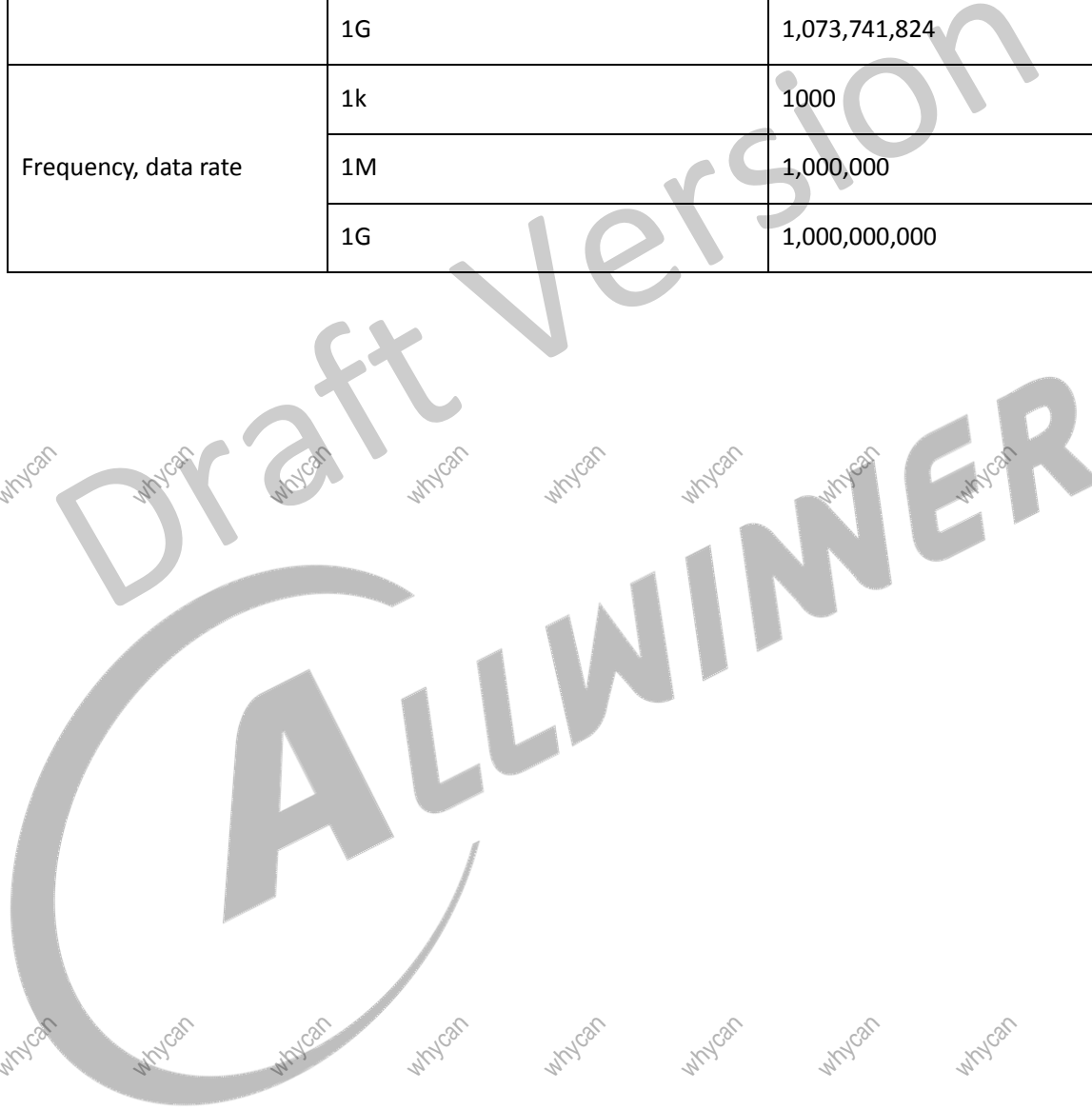

# 1 Overview

D1 is an advanced application processor designed for RISC-V Multi-Media decoding platform. It integrates a 64-bit XuanTie C906 RISC-V CPU and a HiFi4 DSP to provide the high-efficient computing power. D1 supports full format decoding such as H.265, H.264, MPEG-1/2/4, JPEG, VC1, and so on. The independent encoder can encode in JPEG or MJPEG. Integrated multi ADCs/DACs and I2S/PCM/DMIC/OWA audio interfaces can work seamlessly with the CPU to accelerate multimedia algorithms and improve the user experience. D1 supports RGB/LVDS/MIPI DSI/HDMI/CVBS OUT display output interfaces to meet the requirements of the different screen display. D1 comes with extensive connectivity and interfaces, such as USB, SDIO, EMAC, TWI, UART, SPI, PWM, GPADC, LRADC, TPADC, IR TX&RX, and so on. Besides, D1 can connect with other different peripherals like WiFi and BT via SDIO and UART.

## 2 Features

### 2.1 CPU Architecture

- XuanTie C906 RISC-V CPU
- 32 KB I-cache + 32 KB D-cache

### 2.2 DSP Architecture

- HiFi4
- 32 KB L1 I-cache and 32 KB L1 D-cache
- 64 KB I-ram and 64 KB D-ram

### 2.3 Memory Subsystem

#### 2.3.1 Boot ROM (BROM)

- On-chip memory
- Supports system boot from the following devices:
  - SD card
  - eMMC
  - SPI NOR Flash
  - SPI NAND Flash
- Supports mandatory upgrade process through USB and SD card
- Supports GPIO pin and eFuse module to select the boot media type

#### 2.3.2 SDRAM

- Supports DDR2/DDR3 SDRAM
- Maximum capacity up to 2 GB
- Supports clock frequency up to 533 MHz for DDR2
- Supports clock frequency up to 800 MHz for DDR3

#### 2.3.3 SMHC

- Three SD/MMC host controller (SMHC) interfaces
- The SMHC0 controls the devices that comply with the protocol Secure Digital Memory (SD mem-version 3.0)

- The SMHC1 controls the device that complies with the protocol Secure Digital I/O (SDIO-version 3.0)
- The SMHC2 controls the device that complies with the protocol Multimedia Card (eMMC-version 5.0)
- Maximum performance:
  - SDR mode 150 MHz@1.8 V IO pad
  - DDR mode 100 MHz@1.8 V IO pad
  - DDR mode 50 MHz@3.3 V IO pad
- Supports 1-bit or 4-bit data width
- Supports block size of 1 to 65535 bytes
- Internal 1024-Bytes RX FIFO and 1024-Bytes TX FIFO
- Supports card insertion and removal interrupt
- Supports hardware CRC generation and error detection
- Supports descriptor-based internal DMA controller

## 2.4 Video Engine

- Video decoding
  - H.265 MP@L5.0 up to 4K@30fps or 1080p@60fps
  - H.264 BP/MP/HP@L5.0 up to 4K@24fps or 1080p@60fps
  - H.263 BP up to 1080p@60fps
  - MPEG-4 SP/ASP L5 up to 1080p@60fps
  - MPEG-2 MP/HL up to 1080p@60fps
  - MPEG-1 MP/HL up to 1080p@60fps
  - Xvid up to 1080p@60fps
  - Sorenson Spark up to 1080p@60fps
  - WMV9/VC-1 SP/MP/AP up to 1080p@60fps
  - MJPEG up to 1080p@30fps
- Video encoding
  - JPEG/MJPEG up to 1080p@60fps
  - Supports input picture scaler up/down

## 2.5 Video and Graphics

### 2.5.1 Display Engine (DE)

- Output size up to 2048 x 2048

- Supports two alpha blending channels for main display and one channel for aux display
- Supports four overlay layers in each channel, and has an independent scaler
- Supports potter-duff compatible blending operation
- Supports LBC buffer decoder
- Supports dither output to TCON
- Supports input format Semi-planar YUV422/YUV420/YUV411 and Planar YUV422/YUV420/YUV411, ARGB8888/XRGB8888/RGB888/ARGB4444/ARGB1555/RGB565/palette
- Supports SmartColor2.0 for excellent display experience
  - Adaptive detail/edge enhancement
  - Adaptive color enhancement
  - Adaptive contrast enhancement and fresh tone rectify
- Supports write back for aux display

### 2.5.2 De-interlacer (DI)

- Supports YUV420 (Planar/NV12/NV21) and YUV422 (Planar/NV16/NV61) data format
- Support video resolution from 32x32 to 2048x1280 pixel
- Support Inter-field interpolation/motion adaptive de-interlace method
- Performance: module clock 600M for 1080p@60Hz YUV420

### 2.5.3 Graphic 2D (G2D)

- Supports layer size up to 2048 x 2048 pixels
- Supports pre-multiply alpha image data
- Supports color key
- Supports two pipes Porter-Duff alpha blending
- Supports multiple video formats 4:2:0, 4:2:2, 4:1:1 and multiple pixel formats (8/16/24/32 bits graphics layer)
- Supports memory scan order option
- Supports any format convert function
- Supports 1/16x to 32x resize ratio
- Supports 32-phase 8-tap horizontal anti-alias filter and 32-phase 4-tap vertical anti-alias filter
- Supports window clip
- Supports FillRectangle, BitBlit, StretchBlit and MaskBlit
- Supports horizontal and vertical flip, clockwise 0/90/180/270 degree rotate for normal buffer
- Supports horizontal flip, clockwise 0/90/270 degree rotate for LBC buffer



## 2.6 Video Output

### 2.6.1 RGB and LVDS LCD

- Supports RGB interface with DE/SYNC mode, up to 1920 x 1080@60fps
- Supports serial RGB/dummy RGB interface, up to 800 x 480@60fps
- Supports LVDS interface with dual link, up to 1920 x 1080@60fps
- Supports LVDS interface with single link, up to 1366 x 768@60fps
- Supports i8080 interface, up to 800 x 480@60fps
- Supports BT656 interface for NTSC and PAL
- RGB888, RGB666 and RGB565 with dither function
- Gamma correction with R/G/B channel independence

### 2.6.2 MIPI DSI

- Compliance with MIPI DSI v1.01
- Supports 4-lane MIPI DSI, up to 1280 x 720@60fps and 1920 x 1200@60fps
- Supports non-burst mode with sync pulse/sync event, burst mode and command mode
- Supports pixel format: RGB888, RGB666, RGB666 loosely packed and RGB565
- Supports continuous and non-continuous lane clock modes
- Supports bidirectional communication of all generic commands in LP through data lane 0
- Supports low power data transmission
- Supports ULPS and escape modes
- Hardware checksum capabilities

### 2.6.3 HDMI

- Compatible with HDMI 2.0
- Supports DDC and SCDC
- Integrated CEC hardware engine
- Optional color space converter (CSC): RGB (4:4:4) to/from YCbCr (4:4:4 or 4:2:2)
- Video formats:
  - All CEA-861-E video formats up to 1080p at 60 Hz and 720p/1080i at 120 Hz
  - Optional HDMI 1.4b video formats
    - All CEA-861-E video formats up to 1080p at 120 Hz
    - HDMI 1.4b 4K x 2K video formats

- HDMI 1.4b 3D video modes with up to 340 MHz (TMDS clock)
- Optional HDMI 2.0 video formats
  - All CEA-861-F video formats
  - Dynamic Range and Mastering InfoFrame (DRM, packet header 0x87)
- Audio formats:
  - Uncompressed audio formats: IEC60985 L-PCM audio samples, up to 192 kHz
  - Compressed audio formats: IEC61937 compressed audio, up to 1536 kHz (for HDMI 2.0b)/768 kHz (for HDMI 1.4b)

#### 2.6.4 CVBS OUT

- 1-channel CVBS output
- Supports NTSC and PAL format
- Plug status auto detecting
- 10 bits DAC output

## 2.7 Video Input

### 2.7.1 Parallel CSI

- Supports 8-bit digital camera interface (RAW8/YUV422/YUV420)
- Supports BT656, BT601 interface (YUV422)
- Supports ITU-R BT.656 time-multiplexed format up to 2\*1080p@30fps in DDR sample mode
- Maximum pixel clock of 148.5 MHz
- Supports de-interlacing for interlace video input
- Supports conversion from YUV422 to YUV420, YUV422 to YUV400, YUV420 to YUV400
- Supports horizontal and vertical flip

### 2.7.2 CVBS IN

- 2-channel CVBS input and 1-channel CVBS decoder
- Supports NTSC and PAL format
- Supports YUV422/YUV420 format
- With 1 channel 3D comb filter
- Detection for signal locked and 625 lines
- Programmable brightness, contrast, and saturation
- 10-bit video ADCs

## 2.8 System Peripherals

### 2.8.1 Timer

- The timer module implements the timing and counting functions, which includes timer0, timer1, watchdog, and audio video synchronization (AVS)
- The timer0/timer1 is a 32-bit down counter. The timer0 and timer1 are completely consistent
- The watchdog is used to transmit a reset signal to reset the entire system when an exception occurs in the system
- The AVS is used to synchronize the audio and video. The AVS sub-block includes AVS0 and AVS1, which are completely consistent

### 2.8.2 High Speed Timer (HSTimer)

- The HSTimer module consists of HSTimer0 and HSTimer1. HSTimer0 and HSTimer1 are down counters that implement timing and counting functions. They are completely consistent.
- Configurable 56-bit down timer
- Supports 5 prescale factors
- The clock source is synchronized with AHB0 clock, much more accurate than other timers
- Supports 2 working modes: periodic mode and single counting mode
- Generates an interrupt when the count is decreased to 0

### 2.8.3 Platform-Level Interrupt Controller (PLIC)

- Sampling, priority arbitration and distribution for external interrupt sources
- The interrupt can be configured as machine mode and super user mode
- Up to 256 interrupt source sampling, supporting level interrupt and pulse interrupt
- 32 levels of interrupt priority
- Maintains independently the interrupt enable for each interrupt mode (machine/super user)
- Maintains independently the interrupt threshold for each interrupt mode (machine/super user)
- Configurable access permission for PLIC registers

### 2.8.4 DMAC

- Up to 16-ch DMA
- Provides 32 peripheral DMA requests for data reading and 32 peripheral DMA requests for data writing
- Flexible data width of 8/16/32/64-bit
- Programmable DMA burst length
- Supports linear and IO address modes

- Supports data transfer types with memory-to-memory, memory-to-peripheral, peripheral-to-memory, peripheral-to-peripheral
- Supports transferring data with a linked list
- DRQ response includes waiting mode and handshake mode
- DMA channel supports pause function
- Memory devices support non-aligned transform

### 2.8.5 Clock Controller Unit (CCU)

- 8 PLLs
- One on-chip RC oscillator
- Supports one external 24 MHz DCXO and one external 32.768 kHz oscillator
- Supports clock configuration and clock generation for corresponding modules
- Supports software-controlled clock gating and software-controlled reset for corresponding modules

### 2.8.6 Thermal Sensor Controller (THS)

- One thermal sensor located in CPU
- Temperature accuracy:  $\pm 3^{\circ}\text{C}$  from  $0^{\circ}\text{C}$  to  $+100^{\circ}\text{C}$ ,  $\pm 5^{\circ}\text{C}$  from  $-25^{\circ}\text{C}$  to  $+125^{\circ}\text{C}$
- Averaging filter for thermal sensor reading
- Supports over-temperature protection interrupt and over-temperature alarm interrupt

### 2.8.7 LDO Power

- Integrated 2 LDOs (LDOA, LDOB)
- LDOA: 1.8 V power output, LDOB: 1.35 V/1.5 V/1.8 V power output
- LDOA for IO and analog module, LDOB for SDRAM
- Input voltage is 2.4 V to 3.6 V

### 2.8.8 RTC

- Implements time counter and timing wakeup
- Provides a 16-bit counter for counting day, 5-bit counter for counting hour, 6-bit counter for counting minute, 6-bit counter for counting second
- External connect a 32.768 kHz low-frequency oscillator for count clock
- Timer frequency is 1 kHz
- Configurable initial value by software anytime

- Supports timing alarm, and generates interrupt and wakeup the external devices
- 8 general purpose registers for storing power-off information

### 2.8.9 Reset

- Integrated internal reset
- Reset D1 or other IC

## 2.9 Audio Subsystem

### 2.9.1 Audio Codec

- Two audio digital-to-analog (DAC) channels
  - Supports 16-bit and 20-bit sample resolution
  - 8 kHz to 192 kHz DAC sample rate
  - $100 \pm 2$  dB SNR@A-weight,  $-85 \pm 3$  dB THD+N
- Two audio outputs:
  - One stereo headphone output: HPOUTL/R
  - One stereo differential lineout output: LINEOUTLP/N and LINEOUTRP/N
- Three audio analog-to-digital (ADC) channels
  - Supports 16-bit and 20-bit sample resolution
  - 8 kHz to 48 kHz ADC sample rate
  - $95 \pm 3$  dB SNR@A-weight,  $-80 \pm 3$  dB THD+N
- Five audio inputs:
  - Three differential microphone inputs: MICIN1P/1N, MICIN2P/2N, MICIN3P/3N
  - One stereo LINEIN input: LINEINL/R
  - One stereo FMIN input: FMINL/R
- Stereo headphone driver
  - $95 \pm 3$  dB SNR@A-weight
  - Output Level  $0.55$  Vrms@ $10$  k $\Omega$ /THD+N  $-77 \pm 3$  dB,  $0.37$  Vrms@ $16$   $\Omega$ /THD+N  $-40$  dB
- Supports Dynamic Range Controller adjusting the DAC playback and ADC recording
- One 128x20-bits FIFO for DAC data transmit, one 128x20-bits FIFO for ADC data receive
- Programmable FIFO thresholds
- Supports interrupts and DMA

## 2.9.2 I2S/PCM

- Three I2S/PCM external interfaces (I2S0, I2S1, I2S2) for connecting external power amplifier and MIC ADC
- Compliant with standard Philips Inter-IC sound (I2S) bus specification
  - Left-justified, Right-justified, PCM mode, and Time Division Multiplexing (TDM) format
  - Programmable PCM frame width: 1 BCLK width (short frame) and 2 BCLKs width (long frame)
- Transmit and Receive data FIFOs
  - Programmable FIFO thresholds
  - 128 depth x 32-bit width TXFIFO and 64 depth x 32-bit width RXFIFO
- Supports multiple function clock
  - Clock up to 24.576 MHz Data Output of I2S/PCM in Master mode (Only if the IO PAD and Peripheral I2S/PCM satisfy Timing Parameters)
  - Clock up to 12.288 MHz Data Input of I2S/PCM in Master mode
- Supports TX/RX DMA slave interface
- Supports multiple application scenarios
  - Up to 16 channels ( $f_s = 48$  kHz) which has adjustable width from 8-bit to 32-bit
  - Sample rate from 8 kHz to 384 kHz (CHAN = 2)
  - 8-bit u-law and 8-bit A-law companded sample
- Supports master/slave mode

## 2.9.3 DMIC

- Supports maximum 8 digital PDM microphones
- Supports sample rate from 8 kHz to 48 kHz

## 2.9.4 One Wire Audio (OWA)

- One OWA TX and one OWA RX
- Compliance with S/PDIF interface
- IEC-60958 and IEC-61937 transmitter and receiver functionality
  - IEC-60958 supports 16-bit, 20-bit, and 24-bit data formats
  - IEC-61937 uses the IEC-60958 series for the conveying of non-linear PCM bit streams, each sub-frame transmits 16-bit
- TXFIFO and RXFIFO
  - One 128x24bits TXFIFO and one 64x24bits RXFIFO for audio data transfer
  - Programmable FIFO thresholds

- Supports TX/RX DMA slave interface
- Supports multiple function clock
  - Separate clock for OWA TX and OWA RX
  - The clock of TX function includes 24.576 MHz and 22.579 MHz frequency
  - The clock of RX function includes 24.576\*8MHz frequency
- Supports hardware parity on TX/RX
  - Hardware parity checking on the receiver
  - Hardware parity generation on the transmitter
- Supports channel status capture on the receiver
- Supports channel sample rate capture on the receiver
- Supports insertion detection for the receiver
- Supports channel status insertion for the transmitter
- Supports interrupts and DMA

## 2.10 Security System

### 2.10.1 Crypto Engine (CE)

- Supports Symmetrical algorithm for encryption and decryption: AES, DES, TDES
  - Supports ECB, CBC, CTS, CTR, CFB, OFB mode for AES
  - Supports 128/192/256-bit key for AES
  - Supports ECB, CBC, CTR mode for DES/TDES
- Supports Hash algorithm for tamper proofing: MD5, SHA, HMAC
  - Supports SHA1, SHA224, SHA256, SHA384, SHA512 for SHA
  - Supports HMAC-SHA1, HMAC-SHA256 for HMAC
  - Supports multi-package mode for MD5/SHA1/SHA224/SHA256/SHA384/SHA512
- Supports Asymmetrical algorithm for signature verification: RSA
  - RSA supports 512/1024/2048-bit width
- Supports 160-bit hardware PRNG with 175-bit seed
- Supports 256-bit hardware TRNG
- Internal DMA controller for data transfer with memory

### 2.10.2 Security ID (SID)

- Supports 2 Kbits eFuse
- Backup eFuse information by using SID\_SRAM

- Burning the key to the SID
- Reading the key use status in the SID
- Loading the key to the CE

## 2.11 External Peripherals

### 2.11.1 USB DRD

- One USB 2.0 DRD (USB0), with integrated USB 2.0 analog PHY
- Complies with USB2.0 Specification
- Supports USB Host function
  - Compatible with Enhanced Host Controller Interface (EHCI) Specification, Version 1.0
  - Compatible with Open Host Controller Interface (OHCI) Specification, Version 1.0a
  - Supports High-Speed (HS, 480 Mbit/s), Full-Speed (FS, 12 Mbit/s), and Low-Speed (LS, 1.5 Mbit/s)
  - Supports only 1 USB Root port shared between EHCI and OHCI
- Supports USB Device function
  - Supports High-Speed (HS, 480 Mbit/s) and Full-Speed (FS, 12 Mbit/s)
  - Supports bi-directional endpoint0 (EP0) for Control transfer
  - Up to 10 user-configurable endpoints (EP1+, EP1-, EP2+, EP2-, EP3+, EP3-, EP4+, EP4-, EP5+, EP5-) for Bulk transfer, Isochronous transfer and Interrupt transfer
  - Up to (8 KB + 64 Bytes) FIFO for all EPs (including EP0)
  - Supports interface to an external Normal DMA controller for every EP
- Supports an internal DMA controller for data transfer with memory
- Supports High-Bandwidth Isochronous & Interrupt transfers
- Automated splitting/combining of packets for Bulk transfers
- Supports point-to-point and point-to-multipoint transfer in both Host and Peripheral modes
- Includes automatic ping capabilities
- Soft connect/disconnect function
- Performs all transaction scheduling in hardware
- Power optimization and power management capabilities
- Device and host controller share a 8K SRAM and a physical PHY

### 2.11.2 USB HOST

- One USB 2.0 HOST (USB1), with integrated USB 2.0 analog PHY
- Complies with USB2.0 Specification



- Supports USB2.0 Host function
  - Compatible with Enhanced Host Controller Interface (EHCI) Specification, Version 1.0
  - Compatible with Open Host Controller Interface (OHCI) Specification, Version 1.0a
  - Supports High-Speed (HS, 480 Mbit/s), Full-Speed (FS, 12 Mbit/s) and Low-Speed (LS, 1.5 Mbit/s) Device
  - Supports only 1 USB Root port shared between EHCI and OHCI
- An internal DMA Controller for data transfer with memory

### 2.11.3 EMAC

- One EMAC interface for connecting external Ethernet PHY
- 10/100/1000 Mbit/s Ethernet port with RGMII and RMII interfaces
- Compliant with IEEE 802.3-2002 standard
- Supports both full-duplex and half-duplex operations
- Provides the management data input/output (MDIO) interface for PHY device configuration and management with configurable clock frequencies
- Programmable frame length to support Standard or Jumbo Ethernet frames with sizes up to 16 KB
- Supports a variety of flexible address filtering modes
- Separate 32-bit status returned for transmission and reception packets
- Optimization for packet-oriented DMA transfers with frame delimiters
  - Supports linked-list descriptor list structure
  - Descriptor architecture, allowing large blocks of data transfer with minimum CPU intervention; each descriptor can transfer up to 4 KB of data
  - Comprehensive status reporting for normal operation and transfers with errors
- 4 KB TXFIFO for transmission packets and 16 KB RXFIFO for reception packets
- Programmable interrupt options for different operational conditions

### 2.11.4 UART

- Up to 6 UART controllers (UART0, UART1, UART2, UART3, UART4, UART5)
- UART0, UART4, UART5: 2-wire; UART1, UART2, UART3: 4-wire
- Compatible with industry-standard 16450/16550 UARTs
- Supports IrDA-compatible slow infrared (SIR) format
- Two separate FIFOs: one is RX FIFO, and the other is TX FIFO
  - Each of them is 64 bytes (For UART0)
  - Each of them is 256 bytes (For UART1, UART2, UART3, UART4, and UART5)

- The working reference clock is from the APB bus clock
  - Speed up to 4 Mbit/s with 64 MHz APB clock
  - Speed up to 1.5 Mbit/s with 24 MHz APB clock
- 5 to 8 data bits for RS-232 characters, or 9 bits RS-485 format
- 1, 1.5 or 2 stop bits
- Programmable parity (even, odd, or no parity)
- Supports TX/RX DMA slave controller interface
- Supports software/hardware flow control
- Supports RX DMA Master interface (Only for UART1)
- Supports auto-flow by using CTS & RTS (Only for UART1/2/3)

### 2.11.5 SPI and SPI\_DBI

- Up to 2 SPI controllers (SPI0, SPI1)
- The SPI0 only supports SPI mode; The SPI1 supports SPI mode and display bus interface (DBI) mode
- SPI mode:
  - Full-duplex synchronous serial interface
  - Master/slave configurable
  - Mode0 to Mode3 are supported for both transmit and receive operations
  - 8-bit wide by 64-entry FIFO for both transmit and receive data
  - Polarity and phase of the Chip Select (SPI-CS) and SPI Clock (SPI-CLK) are configurable
  - Supports 3-wire/4-wire SPI
  - Supports programmable serial data frame length: 1-bit to 32-bit
  - Supports Standard SPI, Dual-Output/Dual-Input SPI, Dual IO SPI, Quad-Output/Quad-Input SPI
- DBI mode:
  - Supports DBI Type C 3 Line/4 Line Interface Mode
  - Supports 2 Data Lane Interface Mode
  - Supports RGB111/444/565/666/888 video format
  - Maximum resolution of RGB666 240 x 320@30Hz with single data lane
  - Maximum resolution of RGB888 240 x 320@60Hz or 320 x 480@30Hz with dual data lane
  - Supports Tearing effect
  - Supports software flexible control video frame rate

### 2.11.6 Two Wire Interface (TWI)

- Up to 4 TWI controllers (TWI0, TWI1, TWI2, TWI3)
- Compliant with I2C bus standard
- Supports standard mode (up to 100 kbit/s) and fast mode (up to 400 kbit/s)
- Supports 7-bit and 10-bit device addressing modes
- Supports master mode or slave mode
- Master mode features:
  - Supports the bus arbitration in the case of multiple master devices
  - Supports clock synchronization and bit and byte waiting
  - Supports packet transmission and DMA
- Slave mode features:
  - Interrupt on address detection
- The TWI controller includes one TWI engine and one TWI driver. And the TWI driver supports packet transmission and DMA mode when TWI works in master mode

### 2.11.7 CIR Receiver (CIR\_RX)

- One CIR\_RX interface (IR-RX)
- Full physical layer implementation
- Supports NEC format infra data
- Supports CIR for remote control or wireless keyboard
- 64x8 bits FIFO for data buffer
- Sample clock up to 1 MHz

### 2.11.8 CIR Transmitter (CIR\_TX)

- One CIR\_TX interface (IR-TX)
- Supports arbitrary wave generator
- Configurable carrier frequency
- Supports handshake mode and waiting mode of DMA
- 128 bytes FIFO for data buffer

### 2.11.9 PWM

- Supports 8 independent PWM channels (PWM0 to PWM7)
  - Supports PWM continuous mode output

- Supports PWM pulse mode output, and the pulse number is configurable
- Output frequency range: 0 to 24 MHz or 100 MHz
- Various duty-cycle: 0% to 100%
- Minimum resolution: 1/65536
- Supports 4 complementary pairs output
  - PWM01 pair (PWM0 + PWM1), PWM23 pair (PWM2 + PWM3), PWM45 pair (PWM4 + PWM5), PWM67 pair (PWM6 + PWM7)
  - Supports dead-zone generator, and the dead-zone time is configurable
- Supports 4 group of PWM channel output for controlling stepping motors
  - Supports any plural channels to form a group, and output the same duty-cycle pulse
  - In group mode, the relative phase of the output waveform for each channel is configurable
- Supports 8 channels capture input
  - Supports rising edge detection and falling edge detection for input waveform pulse
  - Supports pulse-width measurement for input waveform pulse

#### 2.11.10 General Purpose ADC (GPADC)

- 2-ch successive approximation register (SAR) analog-to-digital converter (ADC)
- 12-bit sampling resolution and 8-bit precision
- 64 FIFO depth of data register
- Power reference voltage: AVCC, analog input voltage range: 0 to AVCC
- Maximum sampling frequency up to 1 MHz
- Supports three operation modes: single conversion mode, continuous conversion mode, burst conversion mode

#### 2.11.11 Touch Panel ADC (TPADC)

- 12 bit SAR type A/D converter
- Configurable sample frequency up to 750 kHz
- One 32x12 FIFO for storing A/D conversion result
- Supports DMA slave interface
- Supports 4-wire resistive touch panel input detection
  - Supports pen down detection with programmable sensitivity
  - Supports single touch coordinate measurement
  - Supports dual touch detection
  - Supports touch pressure measurement with programmable threshold

- Supports median and averaging filter for noise reduction
- Supports X and Y coordinate exchange function
- Supports Aux ADC with up to 4 channels

### 2.11.12 Low Rate ADC (LRADC)

- One LRADC input channel
- 6-bit sampling resolution and 5-bit precision
- Sample rate up to 2 kHz
- Supports hold Key and general Key
- Supports normal, continuous and single working mode
- Power supply voltage: AVCC, power reference voltage: 0.75\*AVCC, analog input and detected voltage range: 0 to 1.266 V

### 2.11.13 LEDC

- LEDC is used to control the external intelligent control LED lamp
- Configurable LED output high/low level width
- Configurable LED reset time
- LEDC data supports DMA configuration mode and CPU configuration mode
- Maximum 1024 LEDs serial connect
- LED data transfer rate up to 800 kbit/s

## 2.12 Package

- LFBGA 337 balls, 13 mm x 13 mm body size, 0.65 mm ball pitch, 0.35 mm ball size

### 3 Block Diagram

Figure 3-1 shows the system block diagram of the D1.

Figure 3-1 D1 System Block Diagram

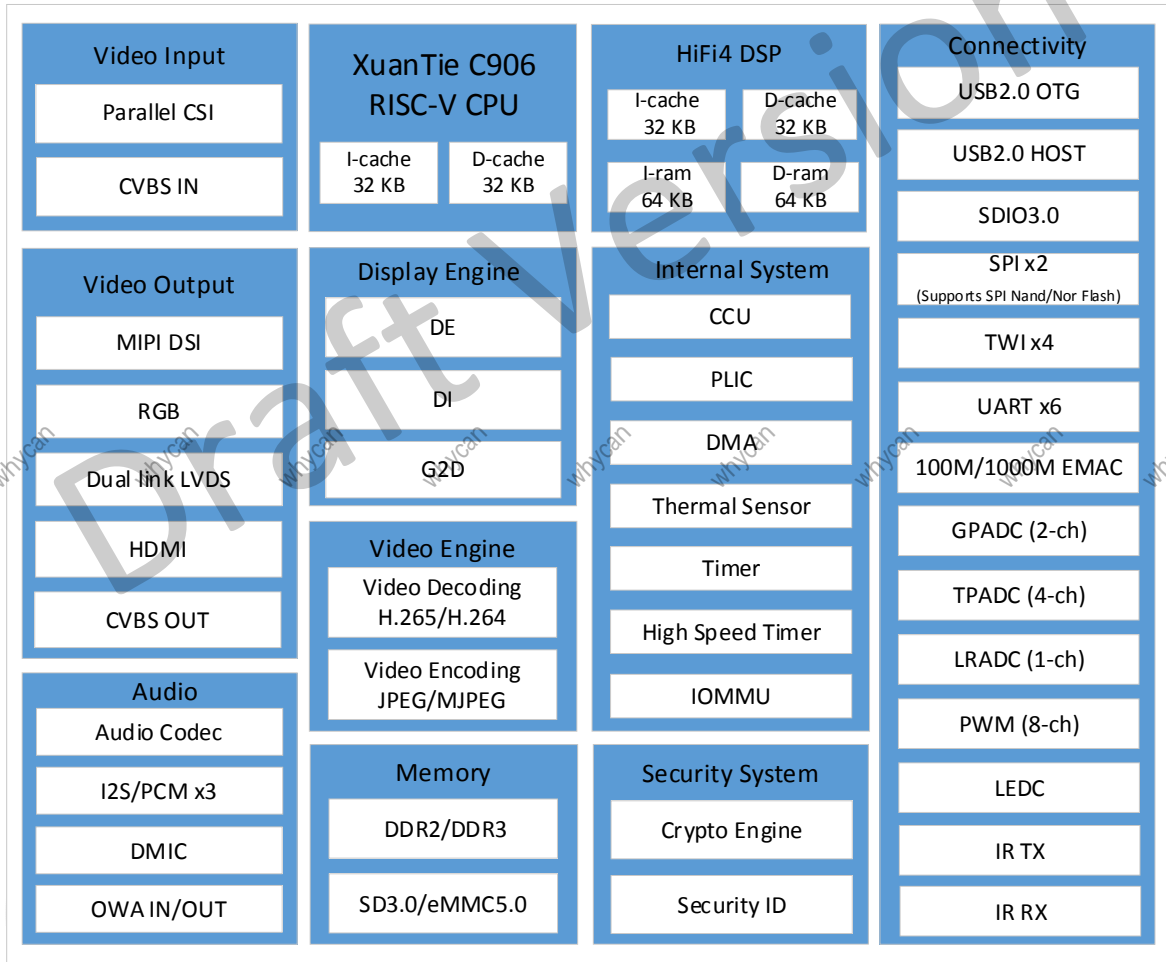
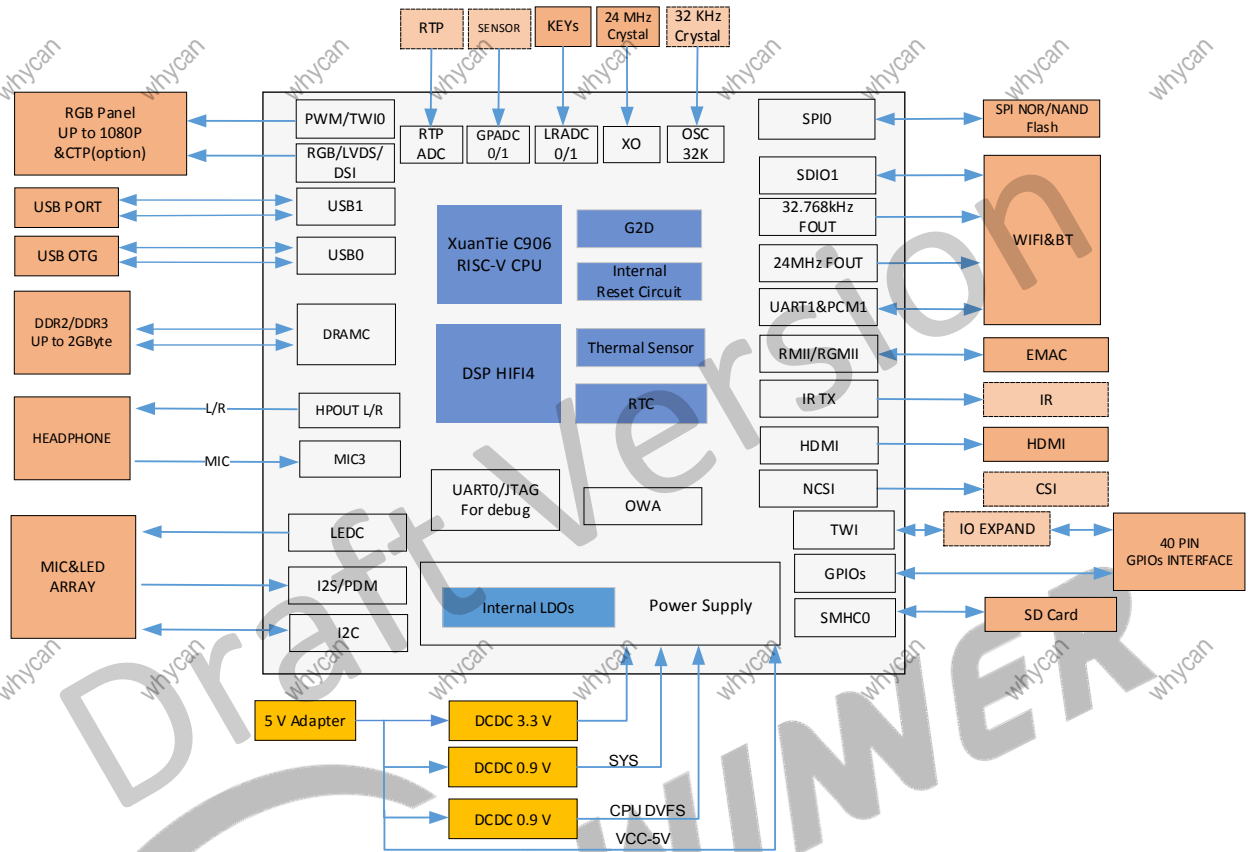

Figure 3-2 shows the solution of D1 multi-media decoding platform.

Figure 3-2 D1 Multi-Media Decoding Platform Solution



## 4 Pin Description

### 4.1 Pin Quantity

Table 4-1 lists the pin quantity of the D1.

**Table 4-1 D1 Pin Quantity**

Pin Type	Quantity
I/O	202
Power	35
Ground	92
DDR Power	8
Total	337

### 4.2 Pin Characteristics

Table 4-2 lists the characteristics of the D1 pins from the following seven aspects.

[1].**Ball#**: Package ball numbers associated with each signal.

[2].**Pin Name**: The name of the package pin.

[3].**Type**: Denotes the signal direction

I (Input),

O (Output),

I/O (Input/Output),

OD (Open-Drain),

A (Analog),

AI (Analog Input),

AO (Analog Output),

P (Power),

G (Ground)

[4].**Ball Reset State**: The state of the terminal at reset. PU: pull up; PD: pull down; Z: high impedance.

[5].**Pull Up/Down**: Denotes the presence of an internal pull-up or pull-down resistor. Pull-up and pull-down resistors can be enabled or disabled via software.

[6].**Default Buffer Strength**: Defines the default drive strength of the associated output buffer. The maximum drive strength of each GPIO is 6 mA.

[7].**Power Supply**: The voltage supply for the IO buffers of the terminal.



Table 4-2 Pin Characteristics

Ball# <sup>[1]</sup>	Pin Name <sup>[2]</sup>	Type <sup>[3]</sup>	Ball State <sup>[4]</sup>	Reset	Pull Up/Down <sup>[5]</sup>	Default Strength <sup>[6]</sup> (mA)	Buffer	Power Supply <sup>[7]</sup>
<b>SDRAM</b>								
V13	SA0	O	NA		NA	NA		VCC-DRAM
W13	SA1	O	NA		NA	NA		VCC-DRAM
V14	SA2	O	NA		NA	NA		VCC-DRAM
U13	SA3	O	NA		NA	NA		VCC-DRAM
U15	SA4	O	NA		NA	NA		VCC-DRAM
V11	SA5	O	NA		NA	NA		VCC-DRAM
W11	SA6	O	NA		NA	NA		VCC-DRAM
Y13	SA7	O	NA		NA	NA		VCC-DRAM
W14	SA8	O	NA		NA	NA		VCC-DRAM
Y15	SA9	O	NA		NA	NA		VCC-DRAM
W12	SA10	O	NA		NA	NA		VCC-DRAM
W15	SA11	O	NA		NA	NA		VCC-DRAM
W16	SA12	O	NA		NA	NA		VCC-DRAM
R15	SA13	O	NA		NA	NA		VCC-DRAM
V16	SA14	O	NA		NA	NA		VCC-DRAM
T15	SA15	O	NA		NA	NA		VCC-DRAM
V10	SBA0	O	NA		NA	NA		VCC-DRAM
W10	SBA1	O	NA		NA	NA		VCC-DRAM
Y11	SBA2	O	NA		NA	NA		VCC-DRAM
W9	SCKE0	O	NA		NA	NA		VCC-DRAM
Y9	SCKE1	O	NA		NA	NA		VCC-DRAM
U10	SCKN	O	NA		NA	NA		VCC-DRAM

Ball# <sup>[1]</sup>	Pin Name <sup>[2]</sup>	Type <sup>[3]</sup>	Ball State <sup>[4]</sup>	Reset	Pull Up/Down <sup>[5]</sup>	Default Strength <sup>[6]</sup> (mA)	Buffer	Power Supply <sup>[7]</sup>
T10	SCKP	O	NA		NA	NA		VCC-DRAM
R12	SCS0	O	NA		NA	NA		VCC-DRAM
R13	SCS1	O	NA		NA	NA		VCC-DRAM
W7	SDQ0	I/O	NA		NA	NA		VCC-DRAM
V7	SDQ1	I/O	NA		NA	NA		VCC-DRAM
W8	SDQ2	I/O	NA		NA	NA		VCC-DRAM
V8	SDQ3	I/O	NA		NA	NA		VCC-DRAM
W4	SDQ4	I/O	NA		NA	NA		VCC-DRAM
Y4	SDQ5	I/O	NA		NA	NA		VCC-DRAM
V5	SDQ6	I/O	NA		NA	NA		VCC-DRAM
W5	SDQ7	I/O	NA		NA	NA		VCC-DRAM
U4	SDQ8	I/O	NA		NA	NA		VCC-DRAM
U7	SDQ9	I/O	NA		NA	NA		VCC-DRAM
U5	SDQ10	I/O	NA		NA	NA		VCC-DRAM
T6	SDQ11	I/O	NA		NA	NA		VCC-DRAM
U6	SDQ12	I/O	NA		NA	NA		VCC-DRAM
R7	SDQ13	I/O	NA		NA	NA		VCC-DRAM
T4	SDQ14	I/O	NA		NA	NA		VCC-DRAM
R6	SDQ15	I/O	NA		NA	NA		VCC-DRAM
Y8	SDQM0	O	NA		NA	NA		VCC-DRAM
W2	SDQM1	O	NA		NA	NA		VCC-DRAM
Y6	SDQS0N	I/O	NA		NA	NA		VCC-DRAM
W6	SDQS0P	I/O	NA		NA	NA		VCC-DRAM
Y3	SDQS1N	I/O	NA		NA	NA		VCC-DRAM

Ball# <sup>[1]</sup>	Pin Name <sup>[2]</sup>	Type <sup>[3]</sup>	Ball State <sup>[4]</sup>	Reset	Pull Up/Down <sup>[5]</sup>	Default Strength <sup>[6]</sup> (mA)	Buffer	Power Supply <sup>[7]</sup>
W3	SDQS1P	I/O	NA		NA	NA		VCC-DRAM
T12	SODT0	O	NA		NA	NA		VCC-DRAM
U12	SODT1	O	NA		NA	NA		VCC-DRAM
T9	SCAS	O	NA		NA	NA		VCC-DRAM
U9	SRAS	O	NA		NA	NA		VCC-DRAM
Y17	SRST	O	NA		NA	NA		VCC-DRAM
U16	SVREF	P	NA		NA	NA		VCC-DRAM
R9	SWE	O	NA		NA	NA		VCC-DRAM
U17	SZQ	AI	NA		NA	NA		VCC-DRAM
N8, N9, N10, P8, P9, P10	VCC-DRAM	P	NA		NA	NA		NA
P14	VDD18-DRAM	P	NA		NA	NA		NA
<b>GPIOB</b>								
J16	PB0	I/O	Z		PU/PD	4		VCC-IO
J17	PB1	I/O	Z		PU/PD	4		VCC-IO
M16	PB2	I/O	Z		PU/PD	4		VCC-IO
M15	PB3	I/O	Z		PU/PD	4		VCC-IO
K16	PB4	I/O	Z		PU/PD	4		VCC-IO
K15	PB5	I/O	Z		PU/PD	4		VCC-IO
K17	PB6	I/O	Z		PU/PD	4		VCC-IO
J15	PB7	I/O	Z		PU/PD	4		VCC-IO
G15	PB8	I/O	Z		PU/PD	4		VCC-IO
G16	PB9	I/O	Z		PU/PD	4		VCC-IO
F17	PB10	I/O	Z		PU/PD	4		VCC-IO

Ball# <sup>[1]</sup>	Pin Name <sup>[2]</sup>	Type <sup>[3]</sup>	Ball State <sup>[4]</sup>	Reset	Pull Up/Down <sup>[5]</sup>	Default Strength <sup>[6]</sup> (mA)	Buffer	Power Supply <sup>[7]</sup>
F15	PB11	I/O	Z		PU/PD	4		VCC-IO
F16	PB12	I/O	Z		PU/PD	4		VCC-IO
<b>GPIOC</b>								
F2	PC0	I/O	Z		PU/PD	4		VCC-PC
F1	PC1	I/O	Z		PU/PD	4		VCC-PC
G3	PC2	I/O	Z		PU/PD	4		VCC-PC
G2	PC3	I/O	PU		PU/PD	4		VCC-PC
H3	PC4	I/O	PU		PU/PD	4		VCC-PC
F5	PC5	I/O	PU		PU/PD	4		VCC-PC
G6	PC6	I/O	Z		PU/PD	4		VCC-PC
G5	PC7	I/O	Z		PU/PD	4		VCC-PC
G4	VCC-PC	P	NA		NA	NA		NA
<b>GPIOD</b>								
W19	PD0	I/O	Z		PU/PD	4		VCC-PD
V20	PD1	I/O	Z		PU/PD	4		VCC-PD
V19	PD2	I/O	Z		PU/PD	4		VCC-PD
U20	PD3	I/O	Z		PU/PD	4		VCC-PD
U19	PD4	I/O	Z		PU/PD	4		VCC-PD
U18	PD5	I/O	Z		PU/PD	4		VCC-PD
T19	PD6	I/O	Z		PU/PD	4		VCC-PD
T18	PD7	I/O	Z		PU/PD	4		VCC-PD
R20	PD8	I/O	Z		PU/PD	4		VCC-PD
R19	PD9	I/O	Z		PU/PD	4		VCC-PD
T17	PD10	I/O	Z		PU/PD	4		VCC-PD

Ball# <sup>[1]</sup>	Pin Name <sup>[2]</sup>	Type <sup>[3]</sup>	Ball State <sup>[4]</sup>	Reset	Pull Up/Down <sup>[5]</sup>	Default Strength <sup>[6]</sup> (mA)	Buffer	Power Supply <sup>[7]</sup>
R17	PD11	I/O	Z		PU/PD	4		VCC-PD
P19	PD12	I/O	Z		PU/PD	4		VCC-PD
P18	PD13	I/O	Z		PU/PD	4		VCC-PD
N17	PD14	I/O	Z		PU/PD	4		VCC-PD
N16	PD15	I/O	Z		PU/PD	4		VCC-PD
N20	PD16	I/O	Z		PU/PD	4		VCC-PD
N19	PD17	I/O	Z		PU/PD	4		VCC-PD
M19	PD18	I/O	Z		PU/PD	4		VCC-PD
M18	PD19	I/O	Z		PU/PD	4		VCC-PD
W18	PD20	I/O	Z		PU/PD	4		VCC-PD
V18	PD21	I/O	Z		PU/PD	4		VCC-PD
Y18	PD22	I/O	Z		PU/PD	4		VCC-PD
R16	VCC-LVDS	P	NA		NA	NA		NA
T16	VCC-PD	P	NA		NA	NA		NA
<b>GPIOE</b>								
V1	PE0	I/O	Z		PU/PD	4		VCC-PE
U1	PE1	I/O	Z		PU/PD	4		VCC-PE
U2	PE2	I/O	Z		PU/PD	4		VCC-PE
U3	PE3	I/O	Z		PU/PD	4		VCC-PE
T2	PE4	I/O	Z		PU/PD	4		VCC-PE
T3	PE5	I/O	Z		PU/PD	4		VCC-PE
R1	PE6	I/O	Z		PU/PD	4		VCC-PE
R2	PE7	I/O	Z		PU/PD	4		VCC-PE
R3	PE8	I/O	Z		PU/PD	4		VCC-PE

Ball#[ <sup>1</sup> ]	Pin Name[ <sup>2</sup> ]	Type[ <sup>3</sup> ]	Ball State[ <sup>4</sup> ]	Reset	Pull Up/Down[ <sup>5</sup> ]	Default Strength[ <sup>6</sup> ]	Buffer (mA)	Power Supply[ <sup>7</sup> ]
P2	PE9	I/O	Z		PU/PD	4		VCC-PE
P3	PE10	I/O	Z		PU/PD	4		VCC-PE
N1	PE11	I/O	Z		PU/PD	4		VCC-PE
R5	PE12	I/O	Z		PU/PD	4		VCC-PE
R4	PE13	I/O	Z		PU/PD	4		VCC-PE
N4	PE14	I/O	Z		PU/PD	4		VCC-PE
N5	PE15	I/O	Z		PU/PD	4		VCC-PE
N6	PE16	I/O	Z		PU/PD	4		VCC-PE
M6	PE17	I/O	Z		PU/PD	4		VCC-PE
M4	VCC-PE	P	NA		NA	NA		NA
<b>GPIOF</b>								
C2	PF0	I/O	Z		PU/PD	4		VCC-PF
C1	PF1	I/O	Z		PU/PD	4		VCC-PF
D2	PF2	I/O	Z		PU/PD	4		VCC-PF
D1	PF3	I/O	Z		PU/PD	4		VCC-PF
E3	PF4	I/O	Z		PU/PD	4		VCC-PF
E2	PF5	I/O	Z		PU/PD	4		VCC-PF
D3	PF6	I/O	Z		PU/PD	4		VCC-PF
F4	VCC-PF	P	NA		NA	NA		NA
<b>GPIOG</b>								
B2	PG0	I/O	Z		PU/PD	4		VCC-PG
B3	PG1	I/O	Z		PU/PD	4		VCC-PG
A3	PG2	I/O	Z		PU/PD	4		VCC-PG
C3	PG3	I/O	Z		PU/PD	4		VCC-PG

Ball# <sup>[1]</sup>	Pin Name <sup>[2]</sup>	Type <sup>[3]</sup>	Ball State <sup>[4]</sup>	Reset	Pull Up/Down <sup>[5]</sup>	Default Strength <sup>[6]</sup> (mA)	Buffer	Power Supply <sup>[7]</sup>
A4	PG4	I/O	Z		PU/PD	4		VCC-PG
B4	PG5	I/O	Z		PU/PD	4		VCC-PG
B5	PG6	I/O	Z		PU/PD	4		VCC-PG
C5	PG7	I/O	Z		PU/PD	4		VCC-PG
A6	PG8	I/O	Z		PU/PD	4		VCC-PG
B6	PG9	I/O	Z		PU/PD	4		VCC-PG
C6	PG10	I/O	Z		PU/PD	4		VCC-PG
D4	PG11	I/O	Z		PU/PD	4		VCC-PG
D5	PG12	I/O	Z		PU/PD	4		VCC-PG
D6	PG13	I/O	Z		PU/PD	4		VCC-PG
E6	PG14	I/O	Z		PU/PD	4		VCC-PG
F6	PG15	I/O	Z		PU/PD	4		VCC-PG
F7	PG16	I/O	Z		PU/PD	4		VCC-PG
E7	PG17	I/O	Z		PU/PD	4		VCC-PG
D7	PG18	I/O	Z		PU/PD	4		VCC-PG
E4	VCC-PG	P	NA		NA	NA		NA
<b>System</b>								
N3	NMI	I/O, OD	NA		NA	NA		VCC-RTC
N2	TEST	I	PD		PU/PD	NA		VCC-RTC
A18	FEL	I	PU		PU/PD	NA		VCC-IO
M2	RESET	I, OD	NA		NA	NA		VCC-RTC
<b>LRADC</b>								
B12	LRADC	AI	NA		NA	NA		AVCC
<b>GPADC</b>								

Ball# <sup>[1]</sup>	Pin Name <sup>[2]</sup>	Type <sup>[3]</sup>	Ball State <sup>[4]</sup>	Reset	Pull Up/Down <sup>[5]</sup>	Default Strength <sup>[6]</sup> (mA)	Buffer	Power Supply <sup>[7]</sup>
C13	GPADC0	AI	NA		NA	NA		AVCC
B13	GPADC1	AI	NA		NA	NA		AVCC
<b>TPADC</b>								
C12	TP-X1	AI	NA		NA	NA		AVCC
A11	TP-X2	AI	NA		NA	NA		AVCC
B11	TP-Y1	AI	NA		NA	NA		AVCC
C11	TP-Y2	AI	NA		NA	NA		AVCC
<b>USB</b>								
C7	USB0-DM	A I/O	NA		NA	NA		VCC-IO
B7	USB0-DP	A I/O	NA		NA	NA		VCC-IO
B8	USB1-DM	A I/O	NA		NA	NA		VCC-IO
A8	USB1-DP	A I/O	NA		NA	NA		VCC-IO
<b>CVBS IN</b>								
B9	TVIN0	AI	NA		NA	NA		VCC-TVIN
C9	TVIN1	AI	NA		NA	NA		VCC-TVIN
E10	TVIN-VRP	AI	NA		NA	NA		VCC-TVIN
F10	TVIN-VRN	AI	NA		NA	NA		VCC-TVIN
D9	VCC-TVIN	P	NA		NA	NA		NA
E9	GND-TVIN	G	NA		NA	NA		NA
<b>CVBS OUT</b>								
E19	TVOUT0	AO	NA		NA	NA		VCC-TVOUT
E18	VCC-TVOUT	P	NA		NA	NA		NA
<b>HDMI</b>								
F19	HCEC	I/O	NA		NA	NA		VCC-HDMI



Ball# <sup>[1]</sup>	Pin Name <sup>[2]</sup>	Type <sup>[3]</sup>	Ball State <sup>[4]</sup>	Reset	Pull Up/Down <sup>[5]</sup>	Default Strength <sup>[6]</sup> (mA)	Buffer	Power Supply <sup>[7]</sup>
F20	HHPD	I/O	NA		NA	NA		VCC-HDMI
G19	HSCL	O	NA		NA	NA		VCC-HDMI
G18	HSDA	I/O	NA		NA	NA		VCC-HDMI
K19	HTX0N	AO	NA		NA	NA		VCC-HDMI
K18	HTX0P	AO	NA		NA	NA		VCC-HDMI
J19	HTX1N	AO	NA		NA	NA		VCC-HDMI
J18	HTX1P	AO	NA		NA	NA		VCC-HDMI
H20	HTX2N	AO	NA		NA	NA		VCC-HDMI
H19	HTX2P	AO	NA		NA	NA		VCC-HDMI
L20	HTXCN	AO	NA		NA	NA		VCC-HDMI
L19	HTXCP	AO	NA		NA	NA		VCC-HDMI
M17	VCC-HDMI	P	NA		NA	NA		NA
<b>Audio Codec</b>								
D20	MICIN1P	AI	NA		NA	NA		AVCC
D19	MICIN1N	AI	NA		NA	NA		AVCC
E15	MICIN2P	AI	NA		NA	NA		AVCC
D15	MICIN2N	AI	NA		NA	NA		AVCC
D17	MICIN3P	AI	NA		NA	NA		AVCC
D16	MICIN3N	AI	NA		NA	NA		AVCC
C17	FMINR	AI	NA		NA	NA		AVCC
B17	FMINL	AI	NA		NA	NA		AVCC
C16	LINEINR	AI	NA		NA	NA		AVCC
B16	LINEINL	AI	NA		NA	NA		AVCC
C15	LINEOUTLN	AO	NA		NA	NA		AVCC

Ball# <sup>[1]</sup>	Pin Name <sup>[2]</sup>	Type <sup>[3]</sup>	Ball State <sup>[4]</sup>	Reset	Pull Up/Down <sup>[5]</sup>	Default Strength <sup>[6]</sup> (mA)	Buffer	Power Supply <sup>[7]</sup>
B15	LINEOUTLP	AO	NA		NA	NA		AVCC
C14	LINEOUTRN	AO	NA		NA	NA		AVCC
B14	LINEOUTRP	AO	NA		NA	NA		AVCC
D13	HPOUTR	AO	NA		NA	NA		HPVCC
F13	HPOUTL	AO	NA		NA	NA		HPVCC
E13	HPOUTFB	AI	NA		NA	NA		HPVCC
D10	HPVCC	P	NA		NA	NA		NA
A13	HP-DET	AI	NA		NA	NA		AVCC
E12	HPLDO	P	NA		NA	NA		NA
D12	HPLDOIN	P	NA		NA	NA		NA
E17	HBIAS	AO	NA		NA	NA		VCC-IO
E16	MBIAS	AO	NA		NA	NA		VCC-IO
A17	MIC-DET	AI	NA		NA	NA		AVCC
B19	VRA1	AO	NA		NA	NA		AVCC
B18	VRA2	AO	NA		NA	NA		AVCC
C20	VDD33	P	NA		NA	NA		NA
C18	AVCC	P	NA		NA	NA		NA
C19	ALDO	P	NA		NA	NA		NA
D18	AGND	G	NA		NA	NA		NA
<b>RTC &amp; PLL</b>								
L2	X32KIN	AI	NA		NA	NA		VCC-RTC
L3	X32KOUT	AO	NA		NA	NA		VCC-RTC
K5	VCC-RTC	P	NA		NA	NA		NA
J5	VCC-PLL	P	NA		NA	NA		NA

Ball# <sup>[1]</sup>	Pin Name <sup>[2]</sup>	Type <sup>[3]</sup>	Ball State <sup>[4]</sup>	Reset	Pull Up/Down <sup>[5]</sup>	Default Strength <sup>[6]</sup> (mA)	Buffer	Power Supply <sup>[7]</sup>
<b>DCXO</b>								
K1	DXIN	AI	NA		NA	NA		VCC-DCXO
K2	DXOUT	AO	NA		NA	NA		VCC-DCXO
J2	REFCLK-OUT	AO	NA		NA	NA		VCC-DCXO
K4	VCC-DCXO	P	NA		NA	NA		NA
<b>Power</b>								
M7	LDO-IN	P	NA		NA	NA		NA
L7	LDOA-OUT	P	NA		NA	NA		NA
N7	LDOB-OUT	P	NA		NA	NA		NA
G17	VCC-IO	P	NA		NA	NA		NA
J4	VCC-EFUSE	P	NA		NA	NA		NA
G13, G14, H13, H14, J13, J14	VDD-SYS	P	NA		NA	NA		NA
G7, G8, H7, H8, H9	VDD-CPU	P	NA		NA	NA		NA
G9	VDD-CPUFB	P	NA		NA	NA		NA
<b>GND</b>								
A1, A15, A19, A2, A20, B1, B10, B20, C10, C4, C8, E5, F12, F18, F3, F9, G10, G11, G12, H1, H10, H11, H12, H18, H2, J10, J11, J12, J3, J6, J7, J8, J9, K10, K11, K12, K13, K14, K3, K6, K7, K8, K9, L10, L11,	GND	G	NA		NA	NA		NA

Ball# <sup>[1]</sup>	Pin Name <sup>[2]</sup>	Type <sup>[3]</sup>	Ball State <sup>[4]</sup>	Reset	Pull Up/Down <sup>[5]</sup>	Default Strength <sup>[6]</sup> (mA)	Buffer	Power Supply <sup>[7]</sup>
L12, L13, L14, L18, L8, L9, M10, M11, M12, M13, M14, M3, M5, M8, M9, N11, N12, N13, N14, N15, N18, P11, P12, P13, P7, R10, R18, T13, T5, T7, V12, V15, V17, V2, V3, V4, V6, V9, W1, W17, W20, Y1, Y19, Y2, Y20								

Draft Version

ALLWINNER

### 4.3 GPIO Multiplex Function

The following table provides a description of the D1 GPIO multiplex function.



**NOTE**

For each GPIO, Function0 is input function; Function1 is output function; Function9 to Function13 are reserved.

**Table 4-3 GPIO Multiplex Function**

Pin Name	GPIO Group	IO Type	Function2	Function3	Function4	Function5	Function6	Function7	Function8	Function14
PB0	GPIOB	I/O	PWM3	IR-TX	TWI2-SCK	SPI1-WP/ DBI-TE	UART0-TX	UART2-TX	OWA-OUT	PB-EINT0
PB1		I/O	PWM4	I2S2-DOUT3	TWI2-SDA	I2S2-DIN3	UART0-RX	UART2-RX	IR-RX	PB-EINT1
PB2		I/O	LCD0-D0	I2S2-DOUT2	TWI0-SDA	I2S2-DIN2	LCD0-D18	UART4-TX		PB-EINT2
PB3		I/O	LCD0-D1	I2S2-DOUT1	TWI0-SCK	I2S2-DIN0	LCD0-D19	UART4-RX		PB-EINT3
PB4		I/O	LCD0-D8	I2S2-DOUT0	TWI1-SCK	I2S2-DIN1	LCD0-D20	UART5-TX		PB-EINT4
PB5		I/O	LCD0-D9	I2S2-BCLK	TWI1-SDA	PWM0	LCD0-D21	UART5-RX		PB-EINT5
PB6		I/O	LCD0-D16	I2S2-LRCK	TWI3-SCK	PWM1	LCD0-D22	UART3-TX	CPUBIST0	PB-EINT6
PB7		I/O	LCD0-D17	I2S2-MCLK	TWI3-SDA	IR-RX	LCD0-D23	UART3-RX	CPUBIST1	PB-EINT7
PB8		I/O	DMIC-DATA3	PWM5	TWI2-SCK	SPI1-HOLD/ DBI-DCX/ DBI-WRX	UART0-TX	UART1-TX		PB-EINT8
PB9		I/O	DMIC-DATA2	PWM6	TWI2-SDA	SPI1-MISO/ DBI-SDI/ DBI-TE/ DBI-DCX	UART0-RX	UART1-RX		PB-EINT9
PB10		I/O	DMIC-DATA1	PWM7	TWI0-SCK	SPI1-MOSI/ DBI-SDO	CLK-FANOUT0	UART1-RTS		PB-EINT10
PB11		I/O	DMIC-DATA0	PWM2	TWI0-SDA	SPI1-CLK/ DBI-SCLK	CLK-FANOUT1	UART1-CTS		PB-EINT11
PB12	I/O	DMIC-CLK	PWM0	OWA-IN	SPI1-CS/ DBI-CSX	CLK-FANOUT2	IR-RX		PB-EINT12	
PC0	GPIOC	I/O	UART2-TX	TWI2-SCK	LEDC-DO					PC-EINT0
PC1		I/O	UART2-RX	TWI2-SDA						PC-EINT1
PC2		I/O	SPI0-CLK	SDC2-CLK						PC-EINT2
PC3		I/O	SPI0-CS0	SDC2-CMD						PC-EINT3
PC4		I/O	SPI0-MOSI	SDC2-D2	BOOT-SEL0					PC-EINT4
PC5		I/O	SPI0-MISO	SDC2-D1	BOOT-SEL1					PC-EINT5
PC6		I/O	SPI0-WP	SDC2-D0	UART3-TX	TWI3-SCK	DBG-CLK			PC-EINT6
PC7	I/O	SPI0-HOLD	SDC2-D3	UART3-RX	TWI3-SDA	TCON-TRIG			PC-EINT7	
PD0	GPIOD	I/O	LCD0-D2	LVDS0-V0P	DSI-D0P	TWI0-SCK				PD-EINT0
PD1		I/O	LCD0-D3	LVDS0-V0N	DSI-D0N	UART2-TX				PD-EINT1

Pin Name	GPIO Group	IO Type	Function2	Function3	Function4	Function5	Function6	Function7	Function8	Function14
PD2		I/O	LCD0-D4	LVDS0-V1P	DSI-D1P	UART2-RX				PD-EINT2
PD3		I/O	LCD0-D5	LVDS0-V1N	DSI-D1N	UART2-RTS				PD-EINT3
PD4		I/O	LCD0-D6	LVDS0-V2P	DSI-CKP	UART2-CTS				PD-EINT4
PD5		I/O	LCD0-D7	LVDS0-V2N	DSI-CKN	UART5-TX				PD-EINT5
PD6		I/O	LCD0-D10	LVDS0-CKP	DSI-D2P	UART5-RX				PD-EINT6
PD7		I/O	LCD0-D11	LVDS0-CKN	DSI-D2N	UART4-TX				PD-EINT7
PD8		I/O	LCD0-D12	LVDS0-V3P	DSI-D3P	UART4-RX				PD-EINT8
PD9		I/O	LCD0-D13	LVDS0-V3N	DSI-D3N	PWM6				PD-EINT9
PD10		I/O	LCD0-D14	LVDS1-V0P	SPI1-CS/DBI-CSX	UART3-TX				PD-EINT10
PD11		I/O	LCD0-D15	LVDS1-V0N	SPI1-CLK/DBI-SCLK	UART3-RX				PD-EINT11
PD12		I/O	LCD0-D18	LVDS1-V1P	SPI1-MOSI/DBI-SDO	TWI0-SDA				PD-EINT12
PD13		I/O	LCD0-D19	LVDS1-V1N	SPI1-MISO/DBI-SDI/ DBI-TE/DBI-DCX	UART3-RTS				PD-EINT13
PD14		I/O	LCD0-D20	LVDS1-V2P	SPI1-HOLD/DBI-DCX /DBI-WRX	UART3-CTS				PD-EINT14
PD15		I/O	LCD0-D21	LVDS1-V2N	SPI1-WP/DBI-TE	IR-RX				PD-EINT15
PD16		I/O	LCD0-D22	LVDS1-CKP	DMIC-DATA3	PWM0				PD-EINT16
PD17		I/O	LCD0-D23	LVDS1-CKN	DMIC-DATA2	PWM1				PD-EINT17
PD18		I/O	LCD0-CLK	LVDS1-V3P	DMIC-DATA1	PWM2				PD-EINT18
PD19		I/O	LCD0-DE	LVDS1-V3N	DMIC-DATA0	PWM3				PD-EINT19
PD20		I/O	LCD0-HSYNC	TWI2-SCK	DMIC-CLK	PWM4				PD-EINT20
PD21		I/O	LCD0-VSYNC	TWI2-SDA	UART1-TX	PWM5				PD-EINT21
PD22		I/O	OWA-OUT	IR-RX	UART1-RX	PWM7				PD-EINT22
PE0		GPIOE	I/O	NCSI0-HSYNC	UART2-RTS	TWI1-SCK	LCD0-HSYNC			RGMII-RXCTRL /RMII-CRS-DV
PE1	I/O		NCSI0-VSYNC	UART2-CTS	TWI1-SDA	LCD0-VSYNC			RGMII-RXD0/ RMII-RXD0	PE-EINT1
PE2	I/O		NCSI0-PCLK	UART2-TX	TWI0-SCK	CLK-FANOUT0	UART0-TX		RGMII-RXD1/ RMII-RXD1	PE-EINT2
PE3	I/O		NCSI0-MCLK	UART2-RX	TWI0-SDA	CLK-FANOUT1	UART0-RX		RGMII-TXCK/ RMII-TXCK	PE-EINT3
PE4	I/O		NCSI0-D0	UART4-TX	TWI2-SCK	CLK-FANOUT2	D-JTAG-MS	R-JTAG-MS	RGMII-TXD0/ RMII-TXD0	PE-EINT4
PE5	I/O		NCSI0-D1	UART4-RX	TWI2-SDA	LEDC-DO	D-JTAG-DI	R-JTAG-DI	RGMII-TXD1/ RMII-TXD1	PE-EINT5
PE6	I/O		NCSI0-D2	UART5-TX	TWI3-SCK	OWA-IN	D-JTAG-DO	R-JTAG-DO	RGMII-TXCTRL /RMII-TXEN	PE-EINT6
PE7	I/O		NCSI0-D3	UART5-RX	TWI3-SDA	OWA-OUT	D-JTAG-CK	R-JTAG-CK	RGMII-CLKIN/ RMII-RXER	PE-EINT7
PE8	I/O		NCSI0-D4	UART1-RTS	PWM2	UART3-TX	JTAG-MS		MDC	PE-EINT8
PE9	I/O		NCSI0-D5	UART1-CTS	PWM3	UART3-RX	JTAG-DI		MDIO	PE-EINT9

Pin Name	GPIO Group	IO Type	Function2	Function3	Function4	Function5	Function6	Function7	Function8	Function14
PE10		I/O	NCSI0-D6	UART1-TX	PWM4	IR-RX	JTAG-DO		EPHY-25M	PE-EINT10
PE11		I/O	NCSI0-D7	UART1-RX	I2S0-DOUT3	I2S0-DIN3	JTAG-CK		RGMII-TXD2	PE-EINT11
PE12		I/O	TWI2-SCK	NCSI0-FIELD	I2S0-DOUT2	I2S0-DIN2			RGMII-TXD3	PE-EINT12
PE13		I/O	TWI2-SDA	PWM5	I2S0-DOUT0	I2S0-DIN1	DMIC-DATA3		RGMII-RXD2	PE-EINT13
PE14		I/O	TWI1-SCK	D-JTAG-MS	I2S0-DOUT1	I2S0-DIN0	DMIC-DATA2		RGMII-RXD3	PE-EINT14
PE15		I/O	TWI1-SDA	D-JTAG-DI	PWM6	I2S0-LRCK	DMIC-DATA1		RGMII-RXCK	PE-EINT15
PE16		I/O	TWI3-SCK	D-JTAG-DO	PWM7	I2S0-BCLK	DMIC-DATA0			PE-EINT16
PE17		I/O	TWI3-SDA	D-JTAG-CK	IR-TX	I2S0-MCLK	DMIC-CLK			PE-EINT17
PF0	GPIOF	I/O	SDC0-D1	JTAG-MS	R-JTAG-MS	I2S2-DOUT1	I2S2-DIN0			PF-EINT0
PF1		I/O	SDC0-D0	JTAG-DI	R-JTAG-DI	I2S2-DOUT0	I2S2-DIN1			PF-EINT1
PF2		I/O	SDC0-CLK	UART0-TX	TWIO-SCK	LEDC-DO	OWA-IN			PF-EINT2
PF3		I/O	SDC0-CMD	JTAG-DO	R-JTAG-DO	I2S2-BCLK				PF-EINT3
PF4		I/O	SDC0-D3	UART0-RX	TWIO-SDA	PWM6	IR-TX			PF-EINT4
PF5		I/O	SDC0-D2	JTAG-CK	R-JTAG-CK	I2S2-LRCK				PF-EINT5
PF6		I/O		OWA-OUT	IR-RX	I2S2-MCLK	PWM5			PF-EINT6
PG0	GPIOG	I/O	SDC1-CLK	UART3-TX	RGMII-RXCTRL/ RMII-CRS-DV	PWM7				PG-EINT0
PG1		I/O	SDC1-CMD	UART3-RX	RGMII-RXD0/ RMII-RXD0	PWM6				PG-EINT1
PG2		I/O	SDC1-D0	UART3-RTS	RGMII-RXD1/ RMII-RXD1	UART4-TX				PG-EINT2
PG3		I/O	SDC1-D1	UART3-CTS	RGMII-TXCK/ RMII-TXCK	UART4-RX				PG-EINT3
PG4		I/O	SDC1-D2	UART5-TX	RGMII-TXD0/ RMII-TXD0	PWM5				PG-EINT4
PG5		I/O	SDC1-D3	UART5-RX	RGMII-TXD1/ RMII-TXD1	PWM4				PG-EINT5
PG6		I/O	UART1-TX	TWI2-SCK	RGMII-TXD2	PWM1				PG-EINT6
PG7		I/O	UART1-RX	TWI2-SDA	RGMII-TXD3	OWA-IN				PG-EINT7
PG8		I/O	UART1-RTS	TWI1-SCK	RGMII-RXD2	UART3-TX				PG-EINT8
PG9		I/O	UART1-CTS	TWI1-SDA	RGMII-RXD3	UART3-RX				PG-EINT9
PG10		I/O	PWM3	TWI3-SCK	RGMII-RXCK	CLK-FANOUT0	IR-RX			PG-EINT10
PG11		I/O	I2S1-MCLK	TWI3-SDA	EPHY-25M	CLK-FANOUT1	TCON-TRIG			PG-EINT11
PG12		I/O	I2S1-LRCK	TWIO-SCK	RGMII-TXCTRL/ RMII-TXEN	CLK-FANOUT2	PWM0	UART1-TX		PG-EINT12
PG13		I/O	I2S1-BCLK	TWIO-SDA	RGMII-CLKIN/ RMII-RXER	PWM2	LEDC-DO	UART1-RX		PG-EINT13
PG14		I/O	I2S1-DIN0	TWI2-SCK	MDC	I2S1-DOUT1	SPI0-WP	UART1-RTS		PG-EINT14
PG15		I/O	I2S1-DOUT0	TWI2-SDA	MDIO	I2S1-DIN1	SPI0-HOLD	UART1-CTS		PG-EINT15
PG16	I/O	IR-RX	TCON-TRIG	PWM5	CLK-FANOUT2	OWA-IN	LEDC-DO		PG-EINT16	

Pin Name	GPIO Group	IO Type	Function2	Function3	Function4	Function5	Function6	Function7	Function8	Function14
PG17		I/O	UART2-TX	TWI3-SCK	PWM7	CLK-FANOUT0	IR-TX	UART0-TX		PG-EINT17
PG18		I/O	UART2-RX	TWI3-SDA	PWM6	CLK-FANOUT1	OWA-OUT	UART0-RX		PG-EINT18

Draft Version





## 4.4 Detailed Signal Description

Table 4-4 shows the detailed function description of every signal based on the different interface.

[1].**Signal Name:** The name of every signal.

[2].**Description:** The detailed function description of every signal.

[3].**Type:** Denotes the signal direction:

- I (Input),
- O (Output),
- I/O (Input/Output),
- OD (Open-Drain),
- A (Analog),
- AI (Analog Input),
- AO (Analog Output),
- A I/O (Analog Input/Output),
- P (Power),
- G (Ground)

**Table 4-4 Detailed Signal Description**

Signal Name <sup>[1]</sup>	Description <sup>[2]</sup>	Type <sup>[3]</sup>
<b>DRAM</b>		
SA[15:0]	DRAM Address Signal to the Memory Device	O
SBA[2:0]	DRAM Bank Address Signal to the Memory Device	O
SCKE[1:0]	DRAM Clock Enable Signal to the Memory Device	O
SCKN	DRAM Active-Low Clock Signal to the Memory Device	O
SCKP	DRAM Active-High Clock Signal to the Memory Device	O
SCS[1:0]	DRAM Chip Select Signal to the Memory Device	O
SDQ[15:0]	DRAM Bidirectional Data line to the Memory Device	I/O
SDQM[1:0]	DRAM Data Mask Signal to the Memory Device	O
SDQS[1:0]N	DRAM Active-Low Bidirectional Data Strobes to the Memory Device	I/O

Signal Name <sup>[1]</sup>	Description <sup>[2]</sup>	Type <sup>[3]</sup>
SDQS[1:0]P	DRAM Active-High Bidirectional Data Strobes to the Memory Device	I/O
SODT[1:0]	DRAM On-Die Termination Output Signal	O
SCAS	DRAM Column Address Strobe	O
SRAS	DRAM Row Address Strobe	O
SRST	DRAM Reset Signal to the Memory Device	O
SVREF	DRAM Reference Voltage	P
SWE	DRAM Write Enable	O
SZQ	DRAM External Reference Resistor for Impedance Calibration	AI
VCC-DRAM	DRAM Power Supply	P
VDD18-DRAM	Power Supply for DRAM Controller	P
<b>System Control</b>		
BOOT-SEL[1:0]	Boot Media Select	I
RESET	Reset Signal (low active)	I, OD
NMI	Non-maskable Interrupt	I/O, OD
TEST	Test Signal	I
FEL	<p>Boot Select</p> <p>Jump to the Try Media Boot process when FEL is high level, or else enter into the mandatory upgrade process.</p> <p>For more details, see section 3.4 “BROM System” in the <i>D1_User_Manual</i>.</p>	I
<b>Clock</b>		
X32KIN	Clock Input of 32.768 kHz Crystal	AI
X32KOUT	Clock Output of 32.768 kHz Crystal	AO
VCC-RTC	RTC Power	P

Signal Name <sup>[1]</sup>	Description <sup>[2]</sup>	Type <sup>[3]</sup>
VCC-PLL	PLL Power Supply	P
<b>DCXO</b>		
REFCLK-OUT	Digital Compensated Crystal Oscillator Clock Fanout	AO
DXIN	Digital Compensated Crystal Oscillator Input	AI
DXOUT	Digital Compensated Crystal Oscillator Output	AO
VCC-DCXO	Digital Compensated Crystal Oscillator Power	P
<b>USB</b>		
USB0-DM	USB DRD Data Signal DM	A I/O
USB0-DP	USB DRD Data Signal DP	A I/O
USB1-DM	USB HOST Data Signal DM	A I/O
USB1-DP	USB HOST Data Signal DP	A I/O
<b>GPADC</b>		
GPADC0	General Purpose ADC Input Channel 0	AI
GPADC1	General Purpose ADC Input Channel 1	AI
<b>TPADC</b>		
TP-X1	Touch Panel X1 Input	AI
TP-X2	Touch Panel X2 Input	AI
TP-Y1	Touch Panel Y1 Input	AI
TP-Y2	Touch Panel Y2 Input	AI
<b>LRADC</b>		
LRADC	Low Rate ADC	AI
<b>HDMI</b>		
HCEC	HDMI Consumer Electronics Control	I/O
HHPD	HDMI Hot Plug Detection Signal	I/O

Signal Name <sup>[1]</sup>	Description <sup>[2]</sup>	Type <sup>[3]</sup>
HSC_L	HDMI Serial Clock	O
HSDA	HDMI Serial Data	I/O
HTX0N	HDMI Negative TMDS Differential Line Driver Data0 Output	AO
HTX0P	HDMI Positive TMDS Differential Line Driver Data0 Output	AO
HTX1N	HDMI Negative TMDS Differential Line Driver Data1 Output	AO
HTX1P	HDMI Positive TMDS Differential Line Driver Data1 Output	AO
HTX2N	HDMI Negative TMDS Differential Line Driver Data2 Output	AO
HTX2P	HDMI Positive TMDS Differential Line Driver Data2 Output	AO
HTXC_N	HDMI Negative TMDS Differential Line Driver Clock Output	AO
HTXC_P	HDMI Positive TMDS Differential Line Driver Clock Output	AO
VCC-HDMI	HDMI Power	P
<b>CVBS OUT</b>		
TVOUT0	TV CVBS Output	AO
VCC-TVOUT	TV CVBS DAC Power	P
<b>CVBS IN</b>		
TVIN0	TV CVBS Input 0	AI
TVIN1	TV CVBS Input 1	AI
TVIN-VRP	TV CVBS ADC Positive Reference Voltage	P
TVIN-VRN	TV CVBS ADC Negative Reference Voltage	P
VCC-TVIN	TV CVBS ADC Power	P

Signal Name <sup>[1]</sup>	Description <sup>[2]</sup>	Type <sup>[3]</sup>
<b>AUDIO CODEC</b>		
LINEOUTLN	Lineout Left Channel Negative Differential Output	AO
LINEOUTLP	Lineout Left Channel Positive Differential Output	AO
LINEOUTRN	Lineout Right Channel Negative Differential Output	AO
LINEOUTRP	Lineout Right Channel Positive Differential Output	AO
HPOUTR	Headphone Right Output	AO
HPOUTL	Headphone Light Output	AO
HPOUTFB	Pseudo Differential Headphone Ground Reference	AI
HPVCC	Headphone Power 1.8 V	P
MICIN1P	Microphone Differential Positive Input 1	AI
MICIN1N	Microphone Differential Negative Input 1	AI
MICIN2P	Microphone Differential Positive Input 2	AI
MICIN2N	Microphone Differential Negative Input 2	AI
MICIN3P	Microphone Differential Positive Input 3	AI
MICIN3N	Microphone Differential Negative Input 3	AI
FMINR	FMIN Right Input	AI
FMINL	FMIN Left Input	AI
LINEINR	LINEIN Right Single-End Input	AI
LINEINL	LINEIN Left Single-End Input	AI
HP-DET	Headphone Jack Detect	AI
HPLDO	Headphone LDO 1.8 V (bonding with HPVCC)	P
HPLDOIN	Headphone LDO Input 3.3 V	P
VDD33	Analog Power 3.3 V	P
ALDO	Analog Power 1.8 V (bonding with AVCC)	P

Signal Name <sup>[1]</sup>	Description <sup>[2]</sup>	Type <sup>[3]</sup>
HBIAS	Second Bias Voltage Output for Headset Microphone	AO
MBIAS	First Bias Voltage Output for Main Microphone	AO
MIC-DET	Headphone MIC Detect	AI
VRA1	Internal Reference Voltage	AO
VRA2	Internal Reference Voltage	AO
AVCC	Power Supply for Analog Part	P
AGND	Analog Ground	G
<b>LCD</b>		
LCD0-D[23:0]	LCD Data Output	O
LCD0-CLK	LCD Clock The pixel data are synchronized by this clock	O
LCD0-VSYNC	LCD Vertical Sync It indicates one new frame	O
LCD0-HSYNC	LCD Horizontal Sync It indicates one new scan line	O
LCD0-DE	LCD Data Output Enable	O
TCON-TRIG	LCD Sync (TCON outputs to LCD for sync)	O
<b>LVDS</b>		
LVDS0-CKP	LVDS0 Positive Port of Clock	O
LVDS0-CKN	LVDS0 Negative Port of Clock	O
LVDS0-V[3:0]P	LVDS0 Positive Port of Data Channel [3:0]	O
LVDS0-V[3:0]N	LVDS0 Negative Port of Data Channel [3:0]	O
LVDS1-CKP	LVDS1 Positive Port of Clock	O
LVDS1-CKN	LVDS1 Negative Port of Clock	O
LVDS1-V[3:0]P	LVDS1 Positive Port of Data Channel [3:0]	O

Signal Name <sup>[1]</sup>	Description <sup>[2]</sup>	Type <sup>[3]</sup>
LVDS1-V[3:0]N	LVDS1 Negative Port of Data Channel [3:0]	O
<b>DSI</b>		
DSI-D[3:0]P	DSI Differential Data [3:0] Positive Signal	O
DSI-D[3:0]N	DSI Differential Data [3:0] Negative Signal	O
DSI-CKP	DSI Differential Clock Positive Signal	O
DSI-CKN	DSI Differential Clock Negative Signal	O
<b>Parallel CSI</b>		
NCSI0-PCLK	Parallel CSI Pixel Clock	I
NCSI0-MCLK	Parallel CSI Master Clock	O
NCSI0-HSYNC	Parallel CSI Horizontal Synchronous	I
NCSI0-VSYNC	Parallel CSI Vertical Synchronous	I
NCSI0-D[7:0]	Parallel CSI Data Bit	I
NCSI0-FIELD	Parallel CSI Field Index	I
<b>SMHC</b>		
SDC0-CMD	Command Signal for SD Card	I/O, OD
SDC0-CLK	Clock for SD Card	O
SDC0-D[3:0]	Data Input and Output for SD Card	I/O
SDC1-CMD	Command Signal for SDIO WIFI	I/O, OD
SDC1-CLK	Clock for SDIO WIFI	O
SDC1-D[3:0]	Data Input and Output for SDIO WIFI	I/O
SDC2-CMD	Command Signal for eMMC	I/O, OD
SDC2-CLK	Clock for eMMC	O
SDC2-D[3:0]	Data Input and Output for eMMC	I/O
<b>I2S/PCM</b>		

Signal Name <sup>[1]</sup>	Description <sup>[2]</sup>	Type <sup>[3]</sup>
I2S0-MCLK	I2S0 Master Clock	O
I2S0-LRCK	I2S0/PCM0 Sample Rate Clock/Sync	I/O
I2S0-BCLK	I2S0/PCM0 Sample Rate Clock	I/O
I2S0-DOUT[3:0]	I2S0/PCM0 Serial Data Output Channel [3:0]	O
I2S0-DIN[3:0]	I2S0/PCM0 Serial Data Input Channel [3:0]	I
I2S1-MCLK	I2S1 Master Clock	O
I2S1-LRCK	I2S1/PCM1 Sample Rate Clock/Sync	I/O
I2S1-BCLK	I2S1/PCM1 Sample Rate Clock	I/O
I2S1-DOUT[1:0]	I2S1/PCM1 Serial Data Output Channel [1:0]	O
I2S1-DIN[1:0]	I2S1/PCM1 Serial Data Input Channel [1:0]	I
I2S2-MCLK	I2S2 Master Clock	O
I2S2-LRCK	I2S2/PCM2 Sample Rate Clock/Sync	I/O
I2S2-BCLK	I2S2/PCM2 Sample Rate Clock	I/O
I2S2-DOUT[3:0]	I2S2/PCM2 Serial Data Output Channel [3:0]	O
I2S2-DIN[3:0]	I2S2/PCM2 Serial Data Input Channel [3:0]	I
<b>DMIC</b>		
DMIC-CLK	Digital Microphone Clock Output	O
DMIC-DATA[3:0]	Digital Microphone Data Input	I
<b>EMAC</b>		
RGMII-RXD3	RGMII Receive Data3	I
RGMII-RXD2	RGMII Receive Data2	I
RGMII-RXD1/RMII-RXD1	RGMII/RMII Receive Data1	I
RGMII-RXD0/RMII-RXD0	RGMII/RMII Receive Data0	I
RGMII-RXCK	RGMII Receive Clock	I



Signal Name <sup>[1]</sup>	Description <sup>[2]</sup>	Type <sup>[3]</sup>
RGMII-RXCTRL/ RMII-CRS-DV	RGMII Receive Control/RMII Carrier Sense Receive Data Valid	I
RGMII-CLKIN/RMII-RXER	RGMII Transmit Clock from External/RMII Receive Error	I
RGMII-TXD3	RGMII Transmit Data3	O
RGMII-TXD2	RGMII Transmit Data2	O
RGMII-TXD1/RMII-TXD1	RGMII/RMII Transmit Data1	O
RGMII-TXD0/RMII-TXD0	RGMII/RMII Transmit Data0	O
RGMII-TXCK/RMII-TXCK	RGMII/RMII Transmit Clock For RGMII, IO type is output; For RMII, IO type is input	I/O
RGMII-TXCTRL/ RMII-TXEN	RGMII Transmit Control/RMII Transmit Enable	O
MDC	RGMII/RMII Management Data Clock	O
MDIO	RGMII/RMII Management Data Input/Output	I/O
EPHY-25M	25 MHz Output for EMAC PHY	O
<b>OWA</b>		
OWA-IN	One Wire Audio Input	I
OWA-OUT	One Wire Audio Output	O
<b>LEDC</b>		
LEDC-DO	Intelligent Control LED Signal Output	O
<b>Interrupt</b>		
PB-EINT[12:0]	GPIO B Interrupt	I
PC-EINT[7:0]	GPIO C Interrupt	I
PD-EINT[22:0]	GPIO D Interrupt	I
PE-EINT[17:0]	GPIO E Interrupt	I

Signal Name <sup>[1]</sup>	Description <sup>[2]</sup>	Type <sup>[3]</sup>
PF-EINT[6:0]	GPIO F Interrupt	I
PG-EINT[18:0]	GPIO G Interrupt	I
<b>CIR Receiver</b>		
IR-RX	Consumer Infrared Receiver	I
<b>CIR Transmitter</b>		
IR-TX	Consumer Infrared Transmitter	O
<b>PWM</b>		
PWM[7:0]	Pulse Width Modulation Output Channel [7:0]	I/O
<b>SPI&amp;SPI_DBI</b>		
SPI0-CS	SPI0 Chip Select Signal, Low Active	I/O
SPI0-CLK	SPI0 Clock Signal Provides serial interface timing.	I/O
SPI0-MOSI	SPI0 Master Data Out, Slave Data In	I/O
SPI0-MISO	SPI0 Master Data In, Slave Data Out	I/O
SPI0-WP	SPI0 Write Protect, Low Active Protects the memory area against all program or erase instructions. It also can be used for serial data input and output for SPI Quad Input or Quad Output mode.	I/O
SPI0-HOLD	SPI0 Hold Signal Pauses any serial communication with the device without deselecting or resetting it. It also can be used for serial data input and output for SPI Quad Input or Quad Output mode.	I/O
SPI1-CS	SPI1 Chip Select Signal, Low Active	I/O
SPI1-CLK	SPI1 Clock Signal Provides serial interface timing.	I/O
SPI1-MOSI	SPI1 Master Data Out, Slave Data In	I/O

Signal Name <sup>[1]</sup>	Description <sup>[2]</sup>	Type <sup>[3]</sup>
SPI1-MISO	SPI1 Master Data In, Slave Data Out	I/O
SPI1-WP	SPI1 Write Protect, Low Active Protects the memory area against all program or erase instructions. It also can be used for serial data input and output for SPI Quad Input or Quad Output mode.	I/O
SPI1-HOLD	SPI1 Hold Signal Pauses any serial communication with the device without resetting it. It also can be used for serial data input and output for SPI Quad Input or Quad Output mode.	I/O
DBI-CSX	Chip Select Signal, Low Active	I/O
DBI-SCLK	Serial Clock Signal	I/O
DBI-SDO	Data Output Signal	I/O
DBI-SDI	Data Input Signal The data is sampled on the rising edge and the falling edge	I/O
DBI-TE	Tearing Effect Input It is used to capture the external TE signal edge. The rising and falling edge is configurable.	I/O
DBI-DCX	DCX pin is the select output signal of data and command. DCX = 0: register command; DCX = 1: data or parameter.	I/O
DBI-WRX	When DBI operates in dual data lane format, the RGB666 format 2 can use WRX to transfer data	I/O
<b>UART</b>		
UART0-TX	UART0 Data Transmit	O
UART0-RX	UART0 Data Receive	I
UART1-TX	UART1 Data Transmit	O

Signal Name <sup>[1]</sup>	Description <sup>[2]</sup>	Type <sup>[3]</sup>
UART1-RX	UART1 Data Receive	I
UART1-CTS	UART1 Data Clear to Send	I
UART1-RTS	UART1 Data Request to Send	O
UART2-TX	UART2 Data Transmit	O
UART2-RX	UART2 Data Receive	I
UART2-CTS	UART2 Data Clear to Send	I
UART2-RTS	UART2 Data Request to Send	O
UART3-TX	UART3 Data Transmit	O
UART3-RX	UART3 Data Receive	I
UART3-CTS	UART3 Data Clear to Send	I
UART3-RTS	UART3 Data Request to Send	O
UART4-TX	UART4 Data Transmit	O
UART4-RX	UART4 Data Receive	I
UART5-TX	UART5 Data Transmit	O
UART5-RX	UART5 Data Receive	I
<b>TWI</b>		
TWI0-SCK	TWI0 Serial Clock Signal	I/O
TWI0-SDA	TWI0 Serial Data Signal	I/O
TWI1-SCK	TWI1 Serial Clock Signal	I/O
TWI1-SDA	TWI1 Serial Data Signal	I/O
TWI2-SCK	TWI2 Serial Clock Signal	I/O
TWI2-SDA	TWI2 Serial Data Signal	I/O
TWI3-SCK	TWI3 Serial Clock Signal	I/O
TWI3-SDA	TWI3 Serial Data Signal	I/O

Signal Name <sup>[1]</sup>	Description <sup>[2]</sup>	Type <sup>[3]</sup>
<b>JTAG</b>		
JTAG-MS	JTAG Mode Select	I
JTAG-CK	JTAG Clock Signal	I
JTAG-DO	JTAG Data Output	O
JTAG-DI	JTAG Data Input	I
D-JTAG-MS	D-JTAG Mode Select	I
D-JTAG-CK	D-JTAG Clock Signal	I
D-JTAG-DO	D-JTAG Data Output	O
D-JTAG-DI	D-JTAG Data Input	I
R-JTAG-MS	R-JTAG Mode Select	I
R-JTAG-CK	R-JTAG Clock Signal	I
R-JTAG-DO	R-JTAG Data Output	O
R-JTAG-DI	R-JTAG Data Input	I

## 5 Electrical Characteristics

### 5.1 Parameter Conditions

#### 5.1.1 Minimum and Maximum Values

Unless otherwise specified the minimum and maximum values are guaranteed in the worst conditions of ambient temperature, supply voltage, and frequencies by tests in production on 100% of the devices with ambient temperature at  $T_a = 25\text{ }^\circ\text{C}$  and  $T_a = T_a \text{ max}$ .

Data based on characterization results, design simulation, and/or technology characteristics are indicated in the table footnotes and are not tested in production.

#### 5.1.2 Typical Values

Unless otherwise specified, the typical data are based on  $T_a = 25\text{ }^\circ\text{C}$ . They are given only as design guidelines.

#### 5.1.3 Temperature Definitions

- Ambient Temperature— the temperature of the surrounding environment.
- Junction Temperature— the hottest temperature of the silicon chip inside the package.
- Absolute Maximum Junction Temperature— the temperature beyond which damage occurs to the device. The device may not function or meet expected performance at this temperature.
- Recommended Operating Temperature— the junction temperature at which the device operates continuously at the designated performance over the designed lifetime. The reliability of the device may be degraded if the device operates above this temperature. Some devices will not function electrically above this temperature.

### 5.2 Absolute Maximum Ratings

Absolute Maximum Ratings are those values beyond which damage to the device may occur. Table 5-1 specifies the absolute maximum ratings.



#### CAUTION

Stresses beyond those listed under Table 5-1 may affect reliability or cause permanent damage to the device. These are stress ratings only. Functional operation of the device at these or any other conditions beyond those indicated under Section 5.3, *Recommended Operating Conditions*, is not implied. Exposure to absolute maximum rated conditions for extended periods may affect device reliability.

---

**Table 5-1 Absolute Maximum Ratings**

Symbol	Parameter	Min <sup>(1)</sup>	Max <sup>(1)</sup>	Unit
AVCC	Power Supply for Analog Part	-0.3	TBD	V
HPVCC	Headphone Power	-0.3	TBD	V
VCC-PC	Digital GPIO C Power	-0.3	3.96	V
VCC-PD	Digital GPIO D Power	-0.3	3.96	V
VCC-PE	Digital GPIO E Power	-0.3	3.96	V
VCC-PF	Digital GPIO F Power	-0.3	3.96	V
VCC-PG	Digital GPIO G Power	-0.3	3.96	V
VCC-IO	Power Supply for 3.3 V Digital Part	-0.3	3.96	V
VCC-RTC	Power Supply for RTC	-0.3	TBD	V
VCC-PLL	Power Supply for System PLL	-0.3	TBD	V
VCC-LVDS	Power Supply for LVDS	-0.3	TBD	V
VCC-TVIN	Power Supply for CVBS IN	-0.3	TBD	V
VCC-TVOUT	Power Supply for CVBS OUT	-0.3	TBD	V
VCC-HDMI	Power Supply for HDMI	-0.3	TBD	V
VCC-DRAM	Power Supply for DRAM IO and DDR2/DDR3	-0.3	TBD	V
VDD18-DRAM	Power Supply for DRAM Controller	-0.3	TBD	V
VCC-EFUSE	Power Supply for EFUSE Program Mode	-0.3	TBD	V
VCC-DCXO	Power Supply for DCXO	-0.3	TBD	V
VDD-CPU	Power Supply for CPU	-0.3	TBD	V
VDD-SYS	Power Supply for System	-0.3	TBD	V
LDO-IN	Internal LDOA/B Input Voltage	-0.3	3.96	V
LDOA-OUT	Internal LDOA Output Voltage for Analog Device and IO	-0.3	2.16	V
LDOB-OUT	Internal LDOB Output Voltage for VCC-DRAM	-0.3	2.16	V

Symbol	Parameter		Min <sup>(1)</sup>	Max <sup>(1)</sup>	Unit
T <sub>STG</sub>	Storage Temperature		-40	150	°C
T <sub>j</sub>	Working Junction Temperature		-40	125	°C
V <sub>ESD</sub>	Electrostatic Discharge <sup>(2)</sup>	Human Body Model(HBM) <sup>(3)</sup>	TBD	TBD	V
		Charged Device Model(CDM) <sup>(4)</sup>	TBD	TBD	V
I <sub>Latch-up</sub>	Latch-up I-test performance current-pulse injection on each IO pin <sup>(5)</sup>		TBD		
	Latch-up over-voltage performance voltage injection on each IO pin <sup>(6)</sup>		TBD		

- (1) The min/max voltages of power rails are guaranteed by design, not tested in production.
- (2) Electrostatic discharge (ESD) to measure device sensitivity/immunity to damage caused by electrostatic discharges into the devices.
- (3) Level listed above is the passing level per ESDA/JEDEC JS-001-2017.
- (4) Level listed above is the passing level per ESDA/JEDEC JS-002-2018.
- (5) Based on JESD78E; each device is tested with IO pin injection of ±200 mA at room temperature.
- (6) Based on JESD78E; each device is tested with a stress voltage of 1.5 x V<sub>ddmax</sub> at room temperature.

### 5.3 Recommended Operating Conditions

Table 5-2 describes operating conditions of the D1.



**NOTE**

Logic functions and parameter values are not assured out of the range specified in the recommended operating conditions.

**Table 5-2 Recommended Operating Conditions**

Symbol	Parameter	Min	Typ	Max	Unit
T <sub>a</sub>	Ambient Operating Temperature	-20	-	85	°C
T <sub>j</sub>	Working Junction Temperature Range	-20	-	TBD <sup>(1)</sup>	°C
AVCC	Power Supply for Analog Part	1.782	1.8	1.818	V



Symbol	Parameter	Min	Typ	Max	Unit
HPVCC	Headphone Power	1.782	1.8	1.818	V
VCC-PC	Digital GPIO C Power				
	1.8 V voltage	1.62	1.8	1.98	V
	3.3 V voltage	2.97	3.3	3.63	
	Digital GPIO D Power				
VCC-PD	1.8 V voltage	1.62	1.8	1.98	V
	3.3 V voltage	2.97	3.3	3.63	
VCC-PE	Digital GPIO E Power				
	1.8 V voltage	1.62	1.8	1.98	V
	2.8 V voltage	2.52	2.8	3.08	
3.3 V voltage	2.97	3.3	3.63		
VCC-PF	Digital GPIO F Power				
	1.8 V voltage	1.62	1.8	1.98	
	3.3 V voltage	2.97	3.3	3.63	
	Digital GPIO G Power				
VCC-PG	1.8 V voltage	1.62	1.8	1.98	V
	3.3 V voltage	2.97	3.3	3.63	
VCC-IO	Power Supply for Digital Part				
	3.3 V voltage	2.97	3.3	3.63	V
VCC-RTC	Power Supply for RTC	TBD	1.8	TBD	V
VCC-PLL	Power Supply for System PLL	TBD	1.8	TBD	V
VCC-LVDS	Power Supply for LVDS	TBD	1.8	TBD	V
VCC-TVIN	Power Supply for CVBS IN	TBD	1.8	TBD	V
VCC-TVOUT	Power Supply for CVBS OUT	TBD	3.3	TBD	V
VCC-HDMI	Power Supply for HDMI	TBD	1.8	TBD	V
VCC-DRAM	Power Supply for DRAM IO and DDR2	1.7	1.8	1.9	V
	Power Supply for DRAM IO and DDR3	1.425	1.5	1.575	V

Symbol	Parameter	Min	Typ	Max	Unit
VDD18-DRAM	Power Supply for DRAM Controller	1.7	1.8	1.95	V
VCC-EFUSE	Power Supply for EFUSE Program Mode	TBD	1.8	TBD	V
VCC-DCXO	Power Supply for DCXO	TBD	1.8	TBD	V
VDD-CPU	Power Supply for CPU	TBD	0.9	TBD	V
VDD-SYS	Power Supply for System	TBD	0.9	TBD	V
LDO-IN	Internal LDOA/B Input Voltage	2.4	3.3	3.6	V
LDOA-OUT	Internal LDOA Output Voltage for Analog Device and IO	1.782	1.8	1.818	V
LDOB-OUT	Internal LDOB Output Voltage for VCC-DRAM	1.31 1.455 1.746	1.35 <sup>(2)</sup> 1.5 1.8	1.39 1.545 1.854	V

- (1). The chip junction temperature in normal working condition should be less than or equal to the maximum junction temperature in Table 5-2.
- (2). The default voltage of LDOB-OUT is 1.35 V.

## 5.4 Power Consumption Parameters

The current consumption is a function of several parameters and factors such as the operating voltage, ambient temperature, I/O pin loading, device software configuration, operating frequencies, I/O pin switching rate, program location in memory and executed binary code.

The current consumption is measured as described in the following table.



### NOTE

Since the data presented in the following table is based on empirical measurements on small sample size, the results presented are not guaranteed.

**Table 5-3 Power Consumption Parameters**

Parameter	Sub Parameter	Power Supply	Condition	Typ	Max	Unit
Internal	CPU	VDD-CPU	1.0 V,@1.5 GHz, 2 memtester	-	TBD	mA

Parameter	Sub Parameter	Power Supply	Condition	Typ	Max	Unit
Core Power	SYS	VDD-SYS	0.9 V	-	TBD	mA
GPIO Power		VCC-IO	For GPIO, voltage 3.3 V, N=13	-	78	mA
		VCC-PC	For GPIO, voltage 3.3 V, N=8	-	48	mA
		VCC-PD	For GPIO, voltage 3.3 V, N=23	-	138	mA
		VCC-PE	For GPIO, voltage 3.3 V, N=18	-	108	mA
		VCC-PF	For GPIO, voltage 3.3 V, N=7	-	42	mA
		VCC-PG	For GPIO, voltage 3.3 V, N=19	-	114	mA
Memory I/O Power		VCC-DRAM	DDR3, 792 MHz, 1.5 V, 2 memtester	-	TBD	mA
LVDS Power		VCC-LVDS	1.8 V, 700 MHz dual link	-	50	mA
HDMI Power		VCC-HDMI	1.8 V, 4K@30fps	-	35	mA
24 MHz Crystal Oscillator		VCC-PLL	1.8 V	-	2	mA
RTC Power		VCC-RTC	1.8 V	-	0.01	mA
ADC Analog Power		AVCC	1.8 V, 48 kHz sample rate, 5-chs are enabled	-	TBD	mA
DAC Analog Power		AVCC	1.8 V, 48 kHz sample rate, 2-chs are enabled	-	TBD	mA
USB Power		VCC-IO	2 x USB, 3.3 V	-	35	mA

General equation for estimated, maximum power consumption of an group IO power supply:

$$I_{max} = N \times 6 \text{ mA}$$

Where:

N—Number of IO pins supplied by the power line.

The maximum power consumption for each IO is 6 mA.

## 5.5 DC Electrical Characteristics

Table 5-4 summarizes the DC electrical characteristics of the D1. For the interfaces of GPIO function port, refer to the DC parameters in Table 5-4 unless otherwise stated.

**Table 5-4 DC Electrical Characteristics**

(VCC-IO/VCC-PC/VCC-PD/VCC-PE/VCC-PF/VCC-PG)

Symbol	Parameter	Min	Typ	Max	Unit	
V <sub>IH</sub>	High-Level Input Voltage	0.7 * VCC-IO	-	VCC-IO + 0.3	V	
V <sub>IL</sub>	Low-Level Input Voltage	-0.3	-	0.3 * VCC-IO	V	
R <sub>PU</sub>	Input Pull-up Resistance	PC3 to PC7, PF3, PF6	12	15	18	kΩ
		PG0 to PG5	26	33	40	kΩ
		Other GPIOs	80	100	120	kΩ
R <sub>PD</sub>	Input Pull-down Resistance	PC3 to PC7, PF3, PF6	12	15	18	kΩ
		PG0 to PG5	26	33	40	kΩ
		Other GPIOs	80	100	120	kΩ
I <sub>IH</sub>	High-Level Input Current	-	-	10	uA	
I <sub>IL</sub>	Low-Level Input Current	-	-	10	uA	
V <sub>OH</sub>	High-Level Output Voltage	VCC-IO – 0.3	-	VCC-IO	V	
V <sub>OL</sub>	Low-Level Output Voltage	0	-	0.2	V	
I <sub>oz</sub>	Tri-State Output Leakage Current	-10	-	10	uA	
C <sub>IN</sub>	Input Capacitance	-	-	5	pF	
C <sub>OUT</sub>	Output Capacitance	-	-	5	pF	

## 5.6 SDIO Electrical Characteristics

The SDIO electrical parameters are related to different supply voltage.

Figure 5-1 SDIO Voltage Waveform

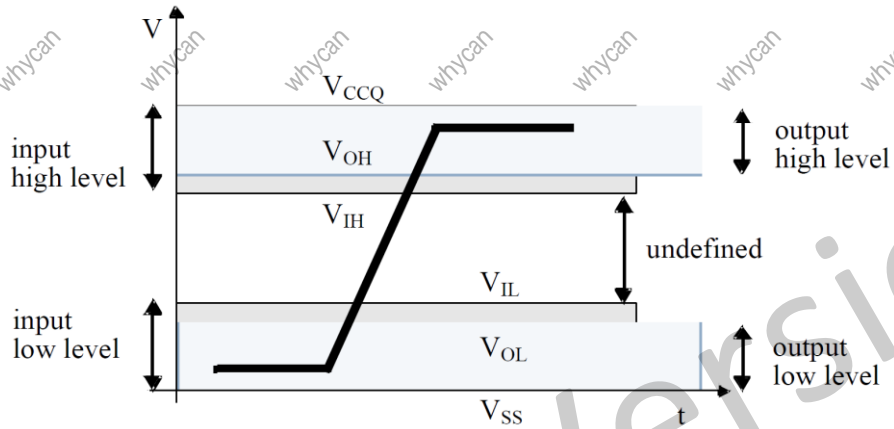

Table 5-5 shows 3.3 V SDIO electrical parameters.

Table 5-5 3.3 V SDIO Electrical Parameters

Symbol	Parameter	Min	Typ	Max	Unit
VDD	Power voltage	2.7	-	3.6	V
VCCQ	I/O voltage	2.7	-	3.6	V
VOH	Output high-level voltage	0.75 * VCCQ	-	-	V
VOL	Output low-level voltage	-	-	0.125 * VCCQ	V
VIH	Input high-level voltage	0.625 * VCCQ	-	VCCQ + 0.3	V
VIL	Input low-level voltage	VSS - 0.3	-	0.25 * VCCQ	V

Table 5-6 shows 1.8 V SDIO electrical parameters.

Table 5-6 1.8 V SDIO Electrical Parameters

Symbol	Parameter	Min	Typ	Max	Unit
VDD	Power voltage	2.7	-	3.6	V
VCCQ	I/O voltage	1.7	-	1.95	V
VOH	Output high-level voltage	VCCQ - 0.45	-	-	V
VOL	Output low-level voltage	-	-	0.45	V
VIH	Input high-level voltage	0.625 * VCCQ <sup>(1)</sup>	-	VCCQ + 0.3	V
VIL	Input low-level voltage	VSS - 0.3	-	0.35 * VCCQ <sup>(2)</sup>	V

Symbol	Parameter	Min	Typ	Max	Unit
(1).	$0.7 * V_{CCQ}$ for MMC4.3 or lower.				
(2).	$0.3 * V_{CCQ}$ for MMC4.3 or lower.				

## 5.7 GPADC Electrical Characteristics

The GPADC contains a 2-ch analog-to-digital (ADC) converter. The GPADC is a type of successive approximation register (SAR) converter. Table 5-7 lists GPADC electrical characteristics.

**Table 5-7 GPADC Electrical Characteristics**

Parameter	Min	Typ	Max	Unit
ADC Resolution	-	12	-	bits
Full-scale Input Range	0	-	AVCC	V
Quantizing Error	-	8	-	LSB
Clock Frequency	-	-	1	MHz
Conversion Time	-	14	-	ADC Clock Cycles

## 5.8 LRADC Electrical Characteristics

The LRADC is 6-bit resolution ADC for key application. The LRADC can work up to 2 kHz conversion rate. Table 5-8 lists LRADC electrical characteristics.

**Table 5-8 LRADC Electrical Characteristics**

Parameter	Min	Typ	Max	Unit
ADC Resolution	-	6	-	bits
Full-scale Input Range	0	-	LEVELB <sup>(1)</sup>	V
Quantizing Error	-	2	-	LSB
Clock Frequency	-	-	2	kHz
Conversion Time	-	6	-	ADC Clock Cycles

(1) The maximum value of LEVELB is 1.266 V. For details, see the register description of LRADC in *Allwinner\_D1\_User\_Manual*.

## 5.9 Audio Codec Electrical Characteristics

### Test Conditions

VDD-SYS = 0.9 V, AVCC = 1.8 V, Ta = 25 °C, 1 kHz sinusoid signal, DAC fs = 48 kHz, ADC fs = 16 kHz, Input gain = 0 dB, 16-bit audio data unless otherwise stated.

**Table 5-9 Audio Codec Typical Performance Parameters**

Symbol	Parameter	Test Conditions	Min	Typ	Max	Unit
DAC Path	<b>DAC to HPOUTL or HPOUTR</b>					
	Full-scale	0dBFS 1 kHz	-	540	-	Vrms
	SNR (A-weighted)	Odata	-	95	-	dB
	THD+N	0dBFS 1 kHz	-	-85	-	dB
	Crosstalk	R_0dB_L_Odata 1 kHz L_0dB_R_Odata 1 kHz	-	TBD	-	dB
	<b>DAC to LINEOUTLP/N or LINEOUTRP/N</b>					
	Full-scale	0dBFS 1 kHz	-	1.1	-	Vrms
	SNR (A-weighted)	Odata	-	100	-	dB
	THD+N	0dBFS 1 kHz	-	-88	-	dB
	Crosstalk	R_0dB_L_Odata 1 kHz L_0dB_R_Odata 1 kHz	-	-105	-	dB
ADC Path	<b>LINEINLR via ADC</b>					
	Output Level	1.7 Vpp, 1 kHz	-	875	-	mFFS
	SNR (A-weighted)	0 Vpp	-	94	-	dB
	THD+N	1.7 Vpp, 1 kHz	-	-88	-	dB
	<b>FMINLR via ADC</b>					
	Output Level	1.7 Vpp, 1 kHz	-	875	-	mFFS
	SNR (A-weighted)	0 Vpp	-	94	-	dB
	THD+N	1.7 Vpp, 1 kHz	-	-88	-	dB
	<b>MICIN via ADC</b>					

Symbol	Parameter	Test Conditions	Min	Typ	Max	Unit
	Output Level	MICP=3.3Vpp/2, MICN=3.3Vpp/2, 1 kHz, 0 dB Gain	-	880	-	mFFS
	SNR (A-weighted)		-	98	-	dB
	THD+N		-	-90	-	dB
	Output Level	MICP=1.695Vpp/2, MICN=1.695Vpp/2, 1 kHz, 6 dB Gain	-	880	-	mFFS
	SNR (A-weighted)		-	97	-	dB
	THD+N		-	-93	-	dB
	Output Level	MICP=0.788Vpp/2, MICN=0.788Vpp/2, 1 kHz, 12 dB Gain	-	880	-	mFFS
	SNR (A-weighted)		-	94	-	dB
	THD+N		-	-85	-	dB
	Output Level	MICP=0.392Vpp/2, MICN=0.392Vpp/2, 1 kHz, 18 dB Gain	-	880	-	mFFS
	SNR (A-weighted)		-	92	-	dB
	THD+N		-	-83	-	dB
	Output Level	MICP=0.197Vpp/2, MICN=0.197Vpp/2, 1 kHz, 24 dB Gain	-	880	-	mFFS
	SNR (A-weighted)		-	87	-	dB
	THD+N		-	-80	-	dB
Output Level	MICP=0.101Vpp/2, MICN=0.101Vpp/2, 1 kHz, 30 dB Gain	-	880	-	mFFS	
SNR (A-weighted)		-	82	-	dB	
THD+N		-	-73	-	dB	
Output Level	MICP=0.053Vpp/2, MICN=0.053Vpp/2, 1 kHz, 36 dB Gain	-	880	-	mFFS	
SNR (A-weighted)		-	76	-	dB	
THD+N		-	-65	-	dB	
MBIAS	Current	-	-	2.0	-	mA
	Voltage	-	1.8	2.0	2.55	V
	Noise	20 Hz—20 kHz	-	3	-	uV



Symbol	Parameter	Test Conditions	Min	Typ	Max	Unit
HBIAS	Current	-	-	2.0	-	mA
	Voltage	-	1.8	2.0	2.55	V
	Noise	20 Hz—20 kHz	-	TBD	-	uV

## 5.10 External Clock Source Characteristics

### 5.10.1 High-speed Crystal/Ceramic Resonator Characteristics

The high-speed external clock can be supplied with a 24 MHz crystal resonator (oscillation mode). The 24 MHz crystal resonator provides 24 MHz reference clock which is connected to the DXIN and DXOUT terminals.

**Table 5-10 High-speed 24 MHz Crystal Circuit Characteristics**

Symbol	Parameter	Min	Typ	Max	Unit
$f_{X24M\_IN}$	Crystal parallel resonance frequency	-	24	-	MHz
	Crystal frequency stability and tolerance at 25 °C <sup>(1)</sup>	-50	-	+50	ppm
	Oscillation mode	Fundamental			-
$C_0$	Shunt capacitance <sup>(2)</sup>	-	6.5	-	pF

1. The 50 ppm frequency stability and tolerance can meet the requirement of D1. We recommend selecting 20 ppm crystal devices. If the REFCLK-OUT (24 MHz fanout) is used for Wi-Fi chip, the crystal uses the recommended specification or the specified model for Wi-Fi chip.
2. The 6.5 pF is only a simulation value. The crystal shunt capacitance ( $C_0$ ) is given by the crystal manufacturer.

**Table 5-11 Crystal Circuit Parameters**

Symbol	Parameter
$C_1$	$C_1$ capacitance
$C_2$	$C_2$ capacitance
$C_L$	Equivalent load capacitance, specified by the crystal manufacturer
$C_0$	Crystal shunt capacitance, specified by the crystal manufacturer
$C_{shunt}$	Total shunt capacitance

Frequency stability mainly requires that the total load capacitance ( $C_L$ ) be constant. The crystal manufacturer typically specifies a total load capacitance which is the series combination of  $C_1$ ,  $C_2$ , and  $C_{shunt}$ .

The total load capacitance is  $C_L = [(C_1 * C_2)/(C_1 + C_2)] + C_{shunt}$ .

- $C_1$  and  $C_2$  represent the total capacitance of the respective PCB trace, load capacitor, and other components (excluding the crystal) connected to each crystal terminal.  $C_1$  and  $C_2$  are usually the same size.
- $C_{shunt}$  is the crystal shunt capacitance ( $C_0$ ) plus any mutual capacitance ( $C_{pkg} + C_{PCB}$ ) seen across the DXIN and DXOUT signals.

In the application, the crystal resonator and the load capacitors must be placed close to the oscillator pins in order to minimize output distortion and the startup stabilization time. Refer to the crystal resonator manufacturer for more details on the resonator characteristics.



**NOTE**

For the above capacitances of 24 MHz crystal circuit, refer to the capacitance recommended in the [D1\\_Schematic\\_Diagram](#).

**5.10.2 Low-speed Crystal/Ceramic Resonator Characteristics**

The D1 contains an RC oscillation circuit that generates a 32.768 kHz clock, meanwhile, the DCXO module can calibrate the RC oscillation circuit regularly. If the product does not have a high requirement for the accuracy of the system clock, the external 32.768 kHz crystal circuit can be omitted and the internal RC oscillation circuit can be adopted, meanwhile, the relevant clock configuration needs to be turned on by the software.

The D1 also can connect to a 32.768 kHz crystal resonator (oscillation mode). The 32.768 kHz crystal resonator provides 32.768 kHz reference clock which is connected to the X32KIN and X32KOUT terminals. In the application, the crystal resonator and the load capacitors must be placed close to the oscillator pins to minimize output distortion and the startup stabilization time. Refer to the crystal resonator manufacturer for more details on the resonator characteristics.

**Table 5-12 Low-speed 32.768 kHz Crystal Circuit Characteristics**

Symbol	Parameter	Min	Typ	Max	Unit
$f_{X32K\_IN}$	Crystal parallel resonance frequency	-	32.768	-	kHz
	Crystal frequency stability and tolerance at 25 °C <sup>(1)</sup>	-	-	-	ppm
	Oscillation mode	Fundamental			-
$C_0$	Shunt capacitance <sup>(2)</sup>	-	1.1	-	pF

1. The D1 has no requirement for the frequency stability and tolerance of 32.768 kHz crystal. If the actual product has requirement for the accuracy of timing function, the 20 ppm stability and tolerance is recommended.
2. The 1.1 pF is only a simulation value. The crystal shunt capacitance ( $C_0$ ) is given by the crystal manufacturer.



**NOTE**

For capacitances of 32.768 kHz crystal circuit, refer to the capacitance recommended in the [D1\\_Schematic\\_Diagram](#).

## 5.11 Internal Reset Electrical Characteristics

Table 5-13 Internal Reset Electrical Characteristics

Parameter	Test Condition	Min	Typ	Max	Unit
Power-on threshold voltage of VDD-SYS on which the reset signal is excited	Ta= -20°C to 85°C	-	TBD	-	V
Reset active timeout period	Ta= -20°C to 85°C	-	TBD	-	ms
Reset open-drain output voltage	Ta= -20°C to 85°C, pull up 3.3 V	-0.3	-	0.3*VCC	V
Power-off threshold voltage of VCC-PL on which the reset signal is excited	The voltage can be enabled by software, and it can be configured as 3.0 V, 2.9 V, 2.8 V, 2.7 V, 2.6 V, or 2.5 V.				

## 5.12 External Memory Electrical Characteristics

### 5.12.1 SMHC AC Electrical Characteristics

#### (1) HS-SDR Mode



**NOTE**

IO voltage is 1.8 V or 3.3 V.

Figure 5-2 SMHC HS-SDR Mode Output Timing Diagram

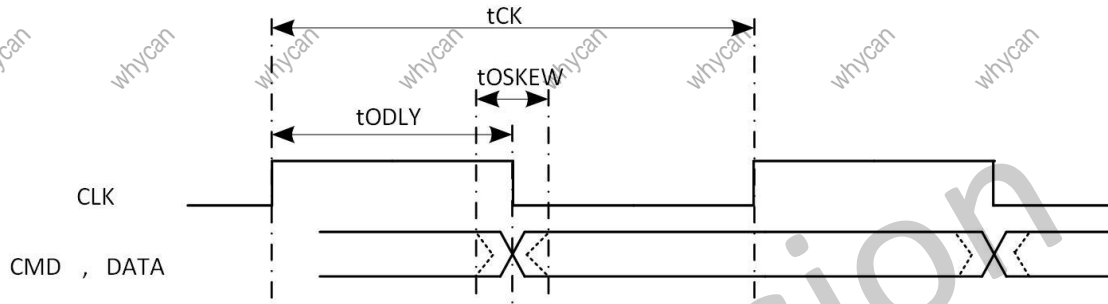

Table 5-14 SMHC HS-SDR Mode Output Timing Constants

Parameter	Symbol	Min	Typ	Max	Unit
<b>CLK</b>					
Clock frequency	tCK	0	50	50	MHz
Duty cycle	DC	45	50	55	%
<b>Output CMD, DATA (referenced to CLK)</b>					
CMD, Data output delay time	tODLY	-	0.25	0.5	UI
Data output delay skew time	tOSKEW	0.5	-	0.8	ns
<p>(1). The Unit Interval (UI) is 1-bit nominal time. For example, UI=20 ns at 50 MHz.</p> <p>(2). The driver strength level of GPIO is 2 for test.</p>					

Figure 5-3 SMHC HS-SDR Mode Input Timing Diagram

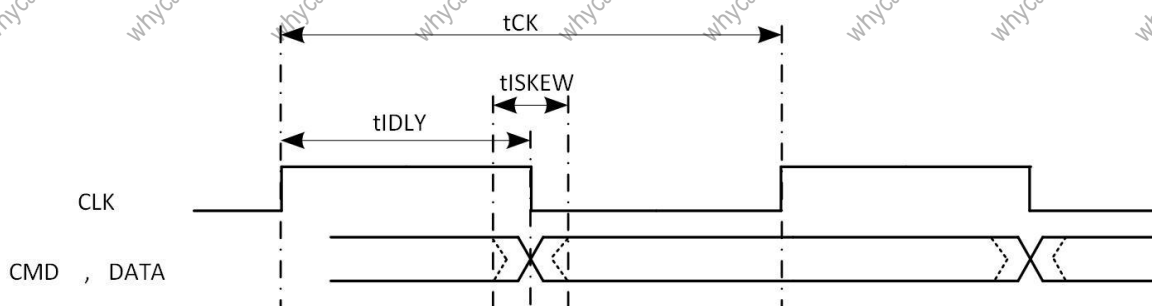

Table 5-15 SMHC HS-SDR Mode Input Timing Constants

Parameter	Symbol	Min	Typ	Max	Unit
-----------	--------	-----	-----	-----	------

Parameter	Symbol	Min	Typ	Max	Unit
<b>CLK</b>					
Clock frequency	tCK	0	50	50	MHz
Duty cycle	DC	45	50	55	%
<b>Input CMD, DATA(referenced to CLK 50 MHz)</b>					
Data input delay in SDR mode. It includes Clock's PCB delay time, Data's PCB delay time and device's data output delay	tIDLY	-	-	-	ns
Data input skew time in SDR mode	tISKEW	0.5	-	0.8	ns
<b>(1). The driver strength level of GPIO is 2 for test.</b>					

(2) HS-DDR Mode

Figure 5-4 SMHC HS-DDR Mode Output Timing Diagram

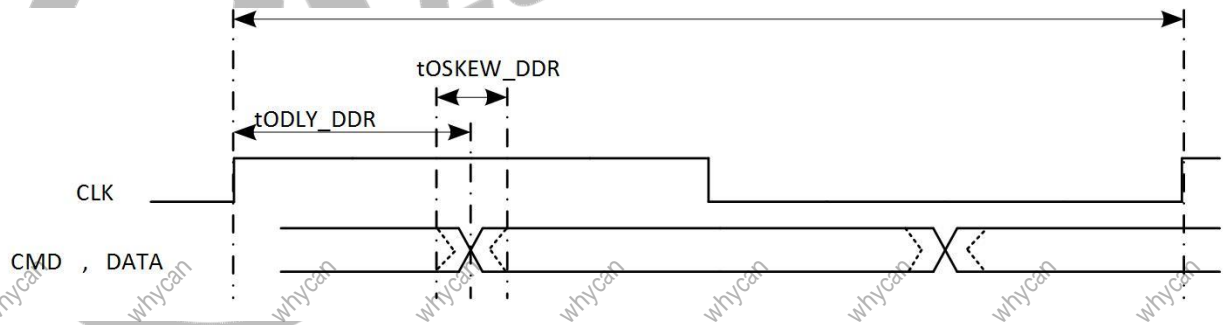

Table 5-16 SMHC HS-DDR Mode Output Timing Constants

Parameter	Symbol	Min	Typ	Max	Unit
<b>CLK</b>					
Clock frequency	tCK	0	50	50	MHz
Duty cycle	DC	45	50	55	%
<b>Output CMD, DATA(referenced to CLK)</b>					
CMD, Data output	tODLY_DDR	-	0.25	0.25	UI

Parameter	Symbol	Min	Typ	Max	Unit
delay time in DDR mode					
Data output delay skew time	tOSKEW_DDR	0.5	-	0.8	ns
<p>(1). The Unit Interval (UI) is 1-bit nominal time. For example, UI=20 ns at 50 MHz.</p> <p>(2). The driver strength level of GPIO is 2 for test.</p>					

Figure 5-5 SMHC HS-DDR Mode Input Timing Diagram

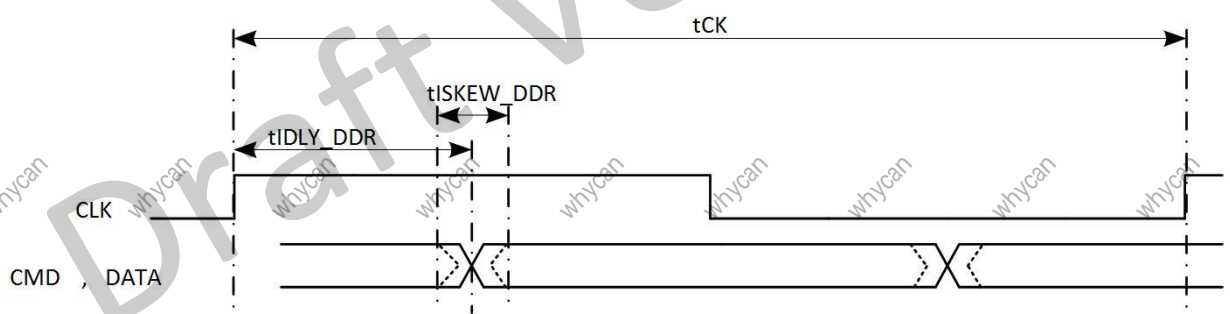

Table 5-17 SMHC HS-DDR Mode Input Timing Constants

Parameter	Symbol	Min	Typ	Max	Unit
<b>CLK</b>					
Clock frequency	tCK	0	50	50	MHz
Duty cycle	DC	45	50	55	%
<b>Input CMD, DATA (referenced to CLK 50 MHz)</b>					
Data input delay in DDR mode. It includes Clock's PCB delay time, Data's PCB delay time and device's data output delay	tIDLY_DDR	-	-	-	ns
Data input skew time in DDR mode	tISKEW_DDR	0.5	-	0.8	ns
<p>(1). The driver strength level of GPIO is 2 for test.</p>					

(3) HS200 Mode

Figure 5-6 SMHC HS200 Mode Output Timing Diagram

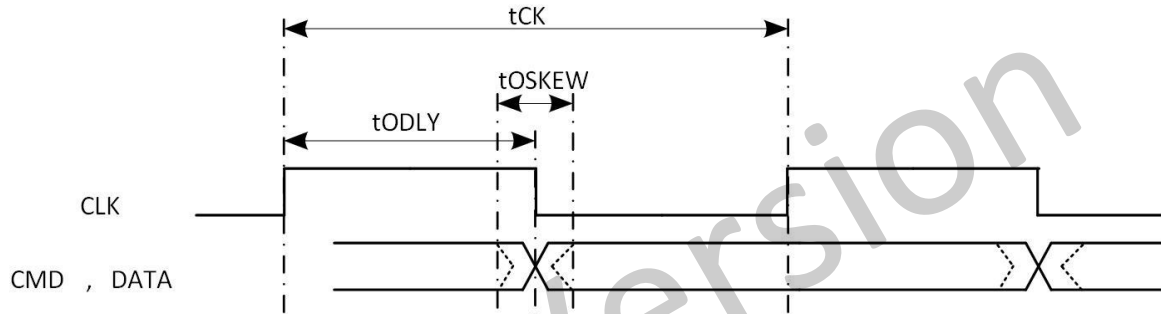

Table 5-18 SMHC HS200 Mode Output Timing Constants

Parameter	Symbol	Min	Typ	Max	Unit
<b>CLK</b>					
Clock frequency	$t_{CK}$	0	-	150	MHz
Duty cycle	DC	45	50	55	%
<b>Output CMD, DATA (referenced to CLK)</b>					
CMD, Data output delay time	$t_{ODLY}$	-	0.25	0.5	UI
Data output delay skew time	$t_{OSKEW}$	0.5	-	0.8	ns
<p>(1). The Unit Interval (UI) is 1-bit nominal time. For example, UI=10 ns at 100 MHz.</p> <p>(2). The driver strength level of GPIO is 3 for test.</p>					

Figure 5-7 SMHC HS200 Mode Input Timing Diagram

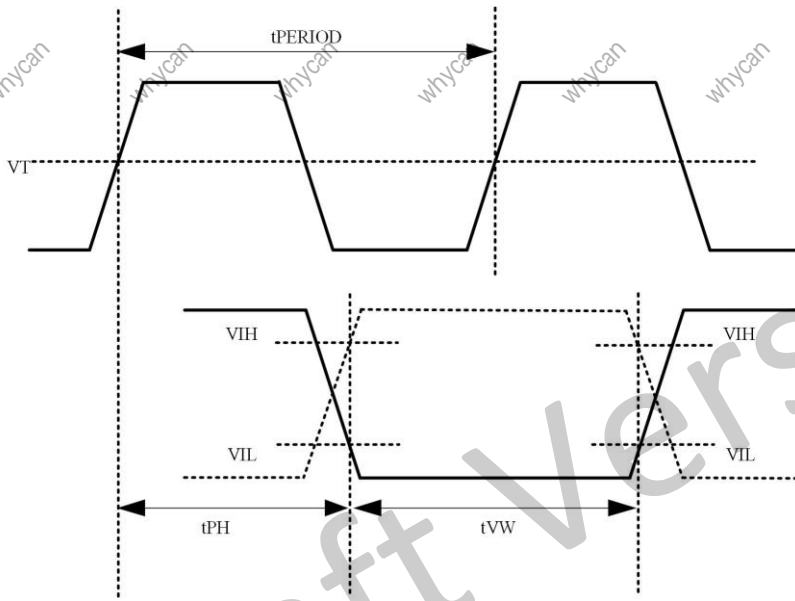

Table 5-19 SMHC HS200 Mode Input Timing Constants

Parameter	Symbol	Min	Typ	Max	Unit	Remark
<b>CLK</b>						
Clock period	tPERIOD	6.66	-	-	ns	Max: 150 MHz
Duty cycle	DC	45	50	55	%	
Rise time, fall time	tTLH, tTHL	-	-	0.2	UI	
<b>Input CMD, DATA (referenced to CLK)</b>						
Input delay	tPH	0	-	2	UI	
Input delay variation due to temperature change after tuning	dPH	-350 <sup>[3]</sup>	-	1550 <sup>[4]</sup>	ps	
CMD, Data valid window	tVW	0.575	-	-	UI	
<p>(1). The Unit Interval (UI) is 1-bit nominal time. For example, UI=10 ns at 100 MHz.</p> <p>(2). The driver strength level of GPIO is 3 for test.</p>						



Parameter	Symbol	Min	Typ	Max	Unit	Remark
<b>(3). Temperature variation: -20°C.</b>						
<b>(4). Temperature variation: 90°C.</b>						

**(4) HS400 Mode**

**Figure 5-8 SMHC HS400 Data Output Timing Diagram**

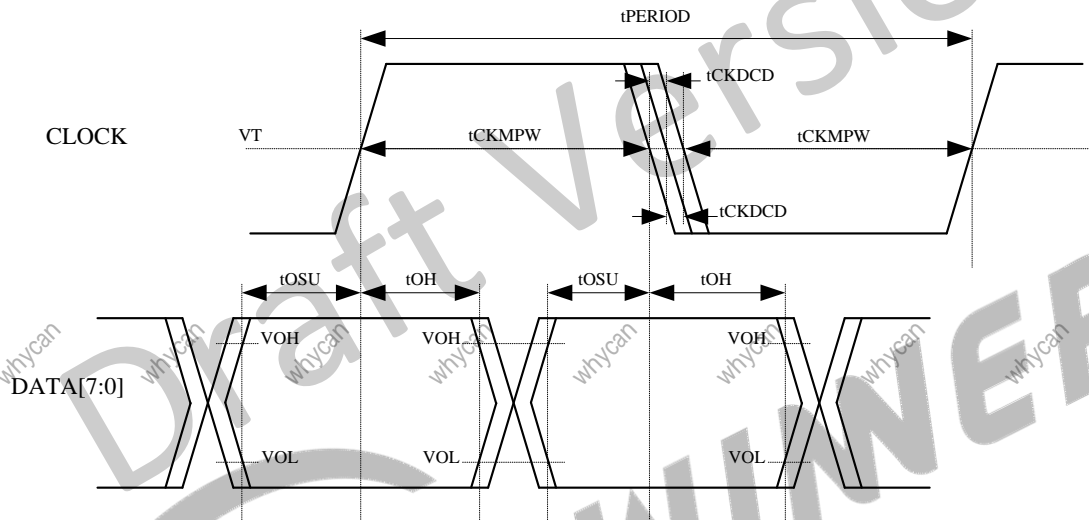

**Table 5-20 SMHC HS400 Output Timing Parameters**

Parameter	Symbol	Min	Typ	Max	Unit	Remark
<b>CLK</b>						
Clock period	tPERIOD	10	-	-	ns	Max:100 MHz
Clock slew rate	SR	1.125	-	-	V/ns	
Clock duty cycle distortion	tCKDCD	0	-	0.5	ns	
Clock minimum pulse width	tCKMPW	2.2	-	-	ns	
<b>Input CMD, DATA (referenced to CLK)</b>						
Data output setup time	tOSU	0.4	-	-	ns	
Data output hold time	tOH	0.4	-	-	ns	

Parameter	Symbol	Min	Typ	Max	Unit	Remark
Data output slew rate	SR	0.9	-	-	ns	
<p>(1). The Unit Interval (UI) is 1-bit nominal time. For example, UI=10 ns at 100 MHz.</p> <p>(2). The driver strength level of GPIO is 3 for test.</p>						

Figure 5-9 SMHC HS400 Data Input Timing Diagram

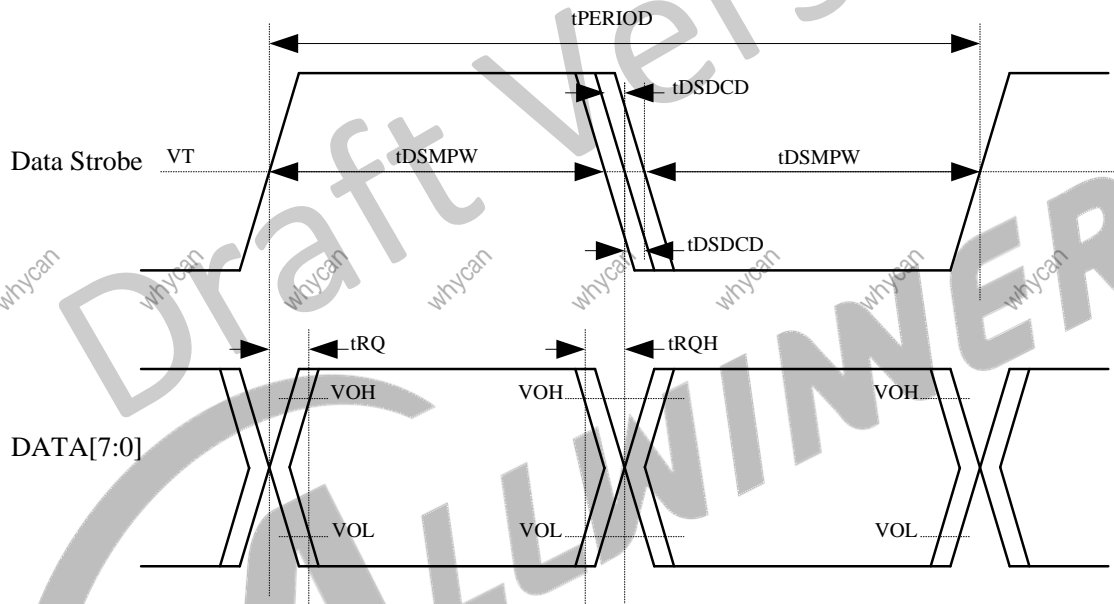

Table 5-21 SMHC HS400 Data Input Timing Parameter

Parameter	Symbol	Min	Typ	Max	Unit	Remark
<b>Data Strobe</b>						
DS period	tPERIOD	10	-	-	ns	Max:100 MHz
DS slew rate	SR	1.125	-	-	V/ns	
DS duty cycle distortion	tDSDCD	0.0	-	0.4	ns	
DS minimum pulse width	tDSMPW	2.0	-	-	ns	
<b>Output DATA (referenced to CLK)</b>						
Data input skew	tRQ	-	-	0.4	ns	

Parameter	Symbol	Min	Typ	Max	Unit	Remark
Data input hold skew	tRQH	-	-	0.4	ns	
Data input slew rate	SR	0.85	-	-	V/ns	

(1). The Unit Interval (UI) is 1-bit nominal time. For example, UI=10 ns at 100 MHz.  
 (2). The driver strength level of GPIO is 3 for test.

## 5.13 External Peripheral Electrical Characteristics

### 5.13.1 EMAC AC Electrical Characteristics

#### 5.13.1.1 RGMII

Figure 5-10 RGMII Interface Transmit Timing

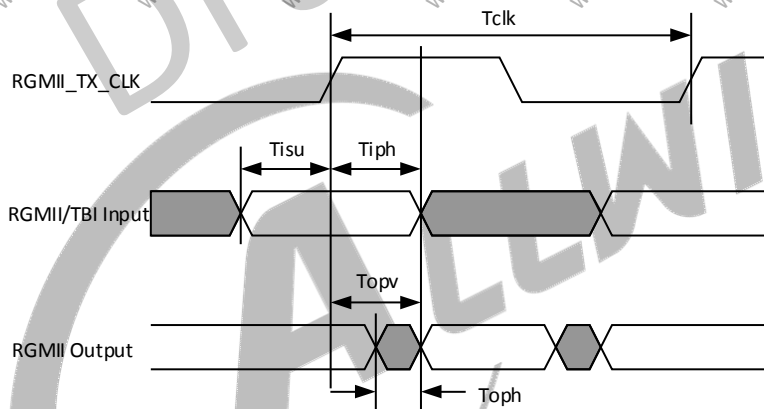

Table 5-22 RGMII Transmit Timing Constants

Parameter	Symbol	Min	Typ	Max	Unit
RGMII_TX_CLK clock period	Tclk	8	-	DC	ns
RGMII/TBI input setup prior to RGMII_TX_CLK	Tisu	2.8	-	-	ns
RGMII/TBI input data hold after RGMII_TX_CLK	Tiph	0.1	-	-	ns
RGMII output data valid after RGMII_TX_CLK	Topv	-	-	0.85	ns
RGMII output data hold after	Toph	0	-	-	ns

Parameter	Symbol	Min	Typ	Max	Unit
RGMII_TX_CLK					

Figure 5-11 RGMII Interface Receive Timing

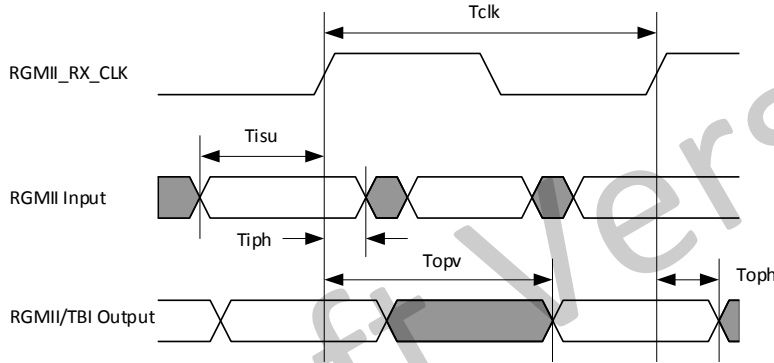
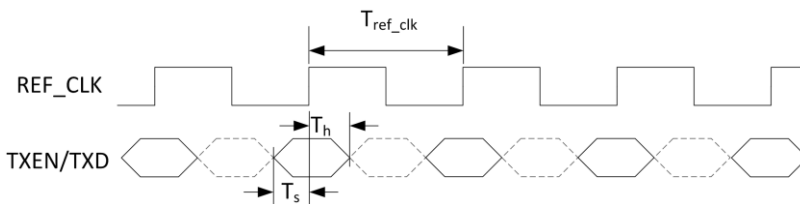

Table 5-23 RGMII Receive Timing Constants

Parameter	Symbol	Min	Typ	Max	Unit
RGMII_RX_CLK clock period	Tclk	8	-	DC	ns
RGMII input setup prior to RGMII_RX_CLK	Tisu	2.6	-	-	ns
RGMII input data hold after RGMII_RX_CLK	Tiph	0.8	-	-	ns
RGMII/TBI input data valid after RGMII_RX_CLK	Topv	-	-	5.2	ns
RGMII output data hold after RGMII_RX_CLK TBI output data hold after RGMII_RX_CLK	Toph	0.1 0.5	-	-	ns

5.13.1.2 RMII

Figure 5-12 RMII Interface Transmit Timing



**Table 5-24 RMII Transmit Timing Constants**

Parameter	Symbol	Min	Typ	Max	Unit
Reference clock period	$T_{ref\_clk}$	-	20	-	ns
TXD/TXEN to REF_CLK setup time	$T_s$	4	-	-	ns
TXD/TXEN to REF_CLK hold time	$T_h$	2	-	-	ns

**Figure 5-13 RMII Interface Receive Timing**

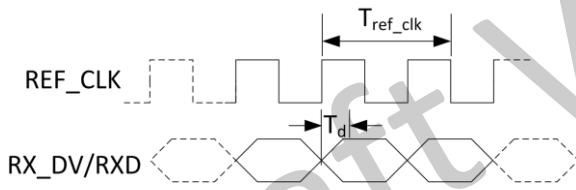

**Table 5-25 RMII Receive Timing Constants**

Parameter	Symbol	Min	Typ	Max	Unit
Reference clock period	$T_{ref\_clk}$	-	20	-	ns
REF_CLK rising edge to RX_DV/RXD	$T_d$	-	10	12	ns

### 5.13.2 SPI AC Electrical Characteristics

**Figure 5-14 SPI Writing Timing**

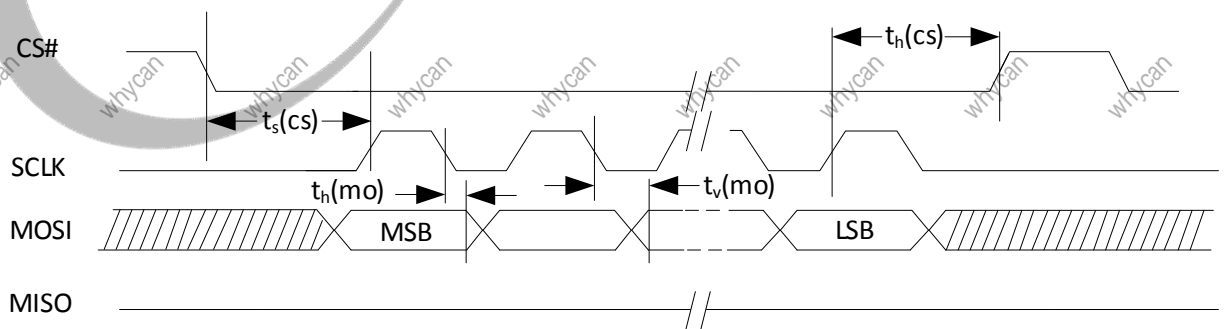

Figure 5-15 SPI Reading Timing

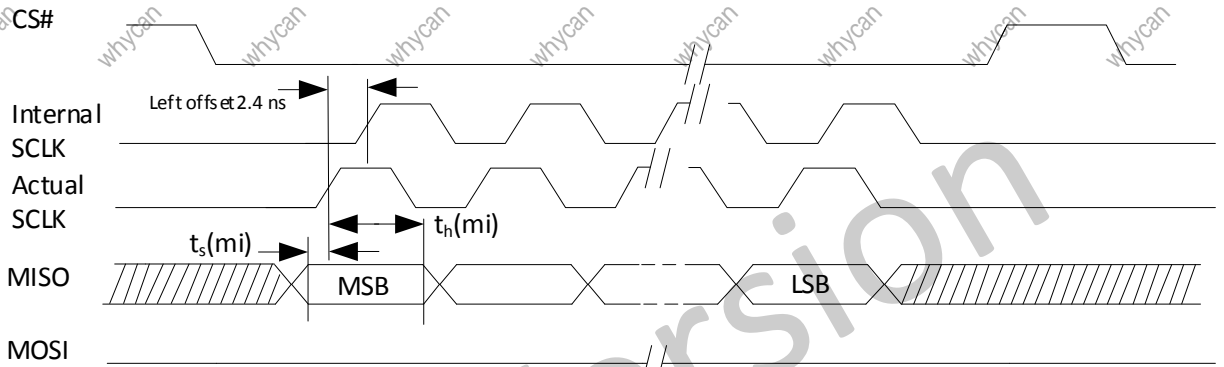

Table 5-26 SPI Timing Constants

Parameter	Symbol	Min	Typ	Max	Unit
CS# active setup time	$t_s(cs)$	-	$2T^{(1)}$	-	ns
CS# active hold time	$t_h(cs)$	-	$2T^{(1)}$	-	ns
Data output valid time	$t_v(mo)$	-	$T^{(1)}/2-3$	-	ns
Data output hold time	$t_h(mo)$	-	$T^{(1)}/2-3$	-	ns
Data input setup time	$t_s(mi)$	0.2	-	-	ns
Data input hold time	$t_h(mi)$	0.2	-	-	ns

(1).T is the cycle of clock.

### 5.13.3 UART AC Electrical Characteristics

Figure 5-16 UART RX Timing

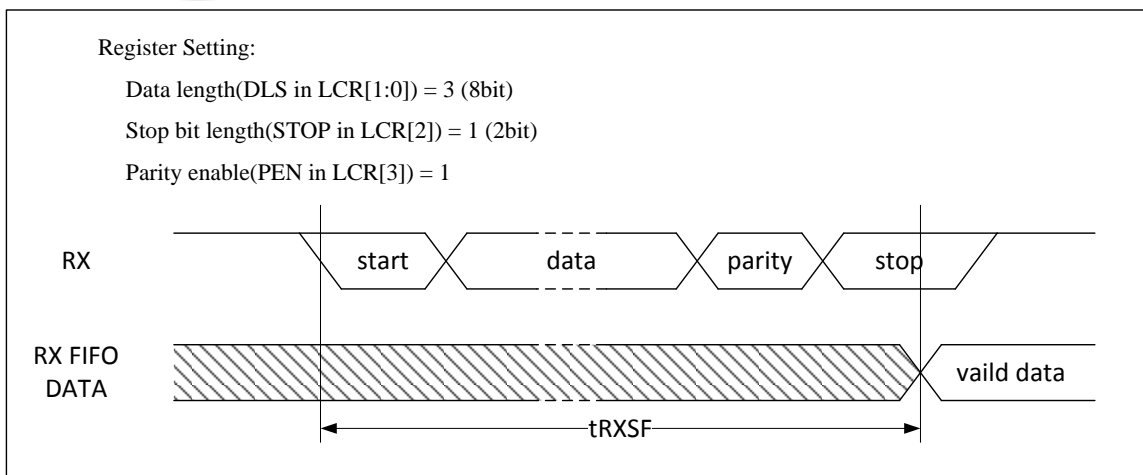

Figure 5-17 UART nCTS Timing

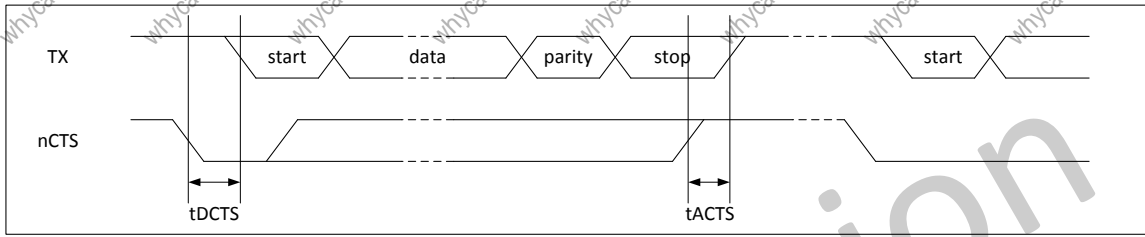

Figure 5-18 UART nRTS Timing

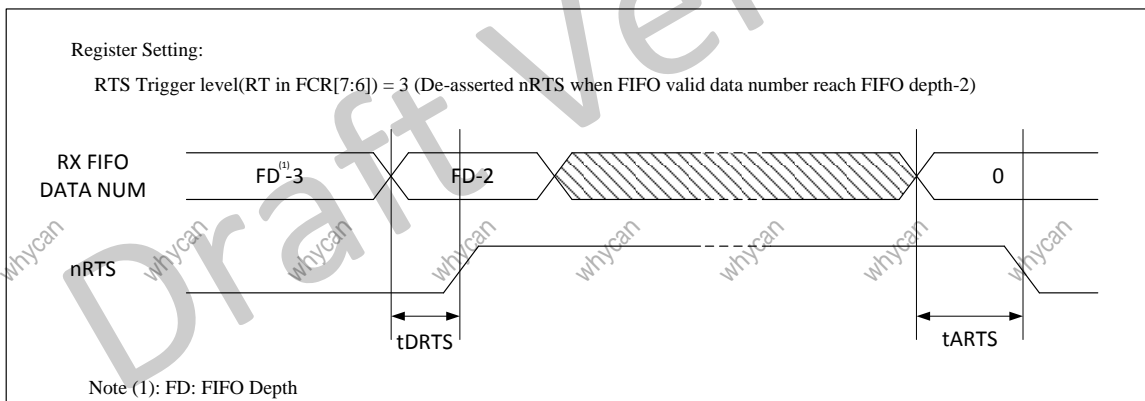

Table 5-27 UART Timing Constants

Parameter	Symbol	Min	Typ	Max	Unit
RX start to RX FIFO	tRXSF	10.5 * BRP <sup>(1)</sup>	-	11 * BRP <sup>(1)</sup>	ns
Delay time of de-asserted nCTS to TX start	tDCTS	-	-	BRP <sup>(1)</sup>	ns
Step time of asserted nCTS to stop next transmission	tACTS	BRP <sup>(1)</sup> /4	-	-	ns
Delay time of de-asserted nRTS	tDRTS	-	-	BRP <sup>(1)</sup>	ns
Delay time of asserted nRTS	tARTS	-	-	BRP <sup>(1)</sup>	ns

**(1). BRP: Baud-Rate Period.**

### 5.13.4 TWI AC Electrical Characteristics

Figure 5-19 TWI Timing

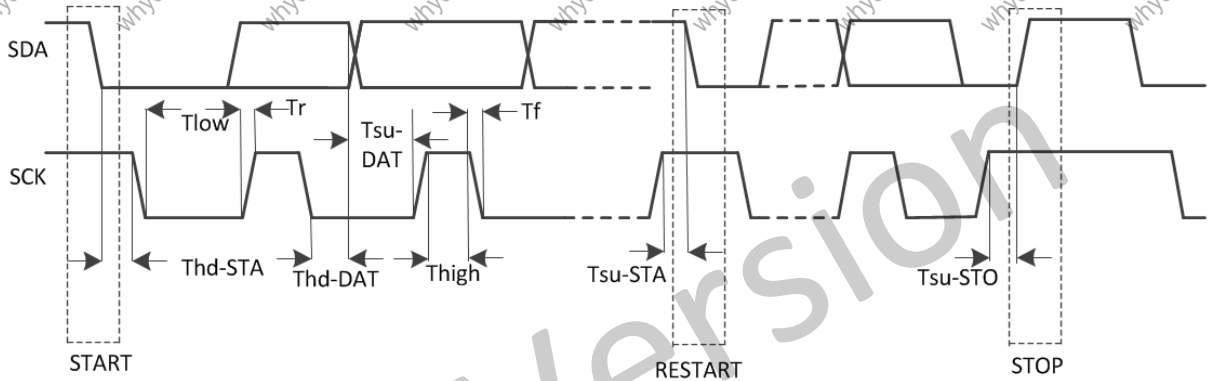

Table 5-28 TWI Timing Parameters

Parameter	Symbol	Standard mode		Fast mode		Unit
		Min	Max	Min	Max	
SCK clock frequency	Fsck	0	100	0	400	kHz
Setup time in Start	Tsu-STA	4.7	-	0.6	-	us
Hold time in Start	Thd-STA	4.0	-	0.6	-	us
Setup time in Data	Tsu-DAT	250	-	100	-	ns
Hold time in Data	Thd-DAT	5.0	-	-	-	ns
Setup time in Stop	Tsu-STO	4.0	-	6.0	-	us
SCK low level time	Tlow	4.7	-	1.3	-	us
SCK high level time	Thigh	4.0	-	0.6	-	ns
SCK/SDA falling time	Tf	-	300	20	300	ns
SCK/SDA rising time	Tr	-	1000	20	300	ns



### 5.13.5 I2S/PCM AC Electrical Characteristics

Figure 5-20 I2S/PCM Timing in Master Mode

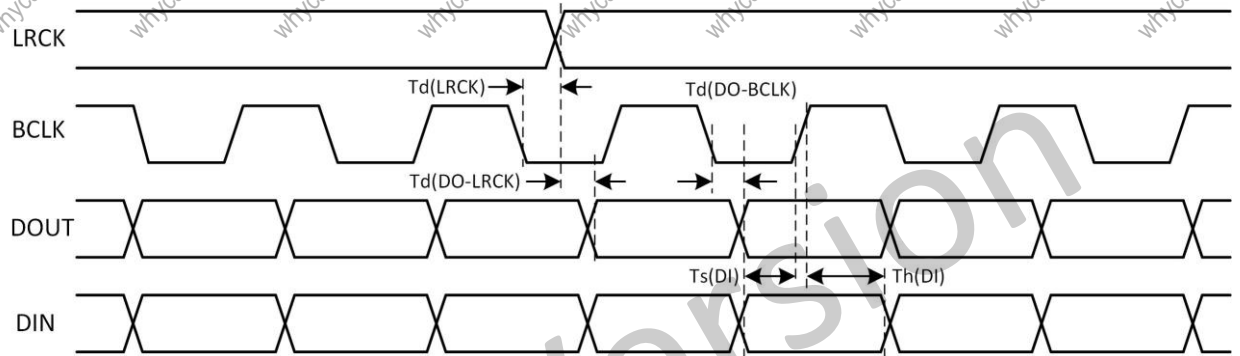

Table 5-29 I2S/PCM Timing Constants in Master Mode

Parameter	Symbol	Min	Typ	Max	Unit
LRCK delay	$T_d(\text{LRCK})$	-	-	10	ns
LRCK to DOUT delay (For LIF)	$T_d(\text{DO-LRCK})$	-	-	10	ns
BCLK to DOUT delay	$T_d(\text{DO-BCLK})$	-	-	10	ns
DIN setup	$T_s(\text{DI})$	4	-	-	ns
DIN hold	$T_h(\text{DI})$	4	-	-	ns
BCLK rise time	$T_r$	-	-	8	ns
BCLK fall time	$T_f$	-	-	8	ns

Figure 5-21 I2S/PCM Timing in Slave Mode

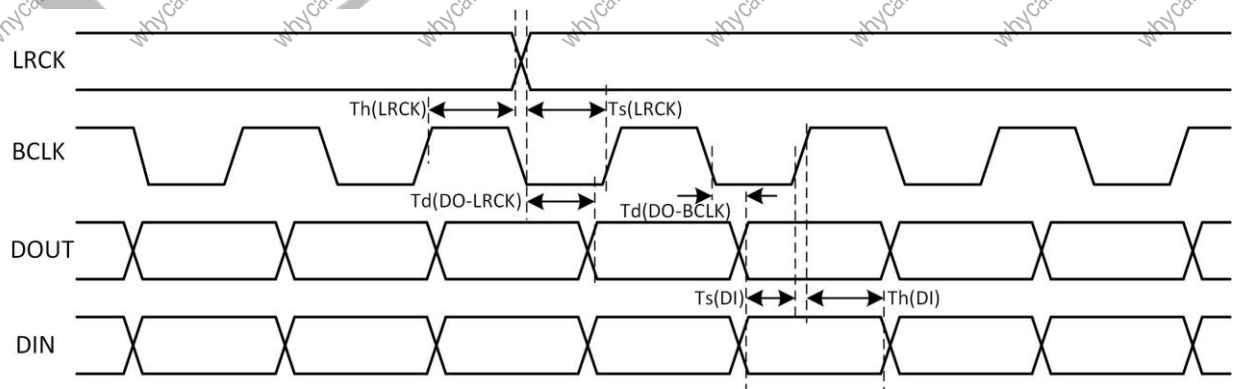

Table 5-30 I2S/PCM Timing Constants in Slave Mode

Parameter	Symbol	Min	Typ	Max	Unit
LRCK setup	$T_s(\text{LRCK})$	4	-	-	ns
LRCK hold	$T_h(\text{LRCK})$	4	-	-	ns
LRCK to DOUT delay (For LJF)	$T_d(\text{DO-LRCK})$	-	-	10	ns
BCLK to DOUT delay	$T_d(\text{DO-BCLK})$	-	-	10	ns
DIN setup	$T_s(\text{DI})$	4	-	-	ns
DIN hold	$T_h(\text{DI})$	4	-	-	ns
BCLK rise time	$T_r$	-	-	4	ns
BCLK fall time	$T_f$	-	-	4	ns

### 5.13.6 DMIC AC Electrical Characteristics

Figure 5-22 DMIC Timing

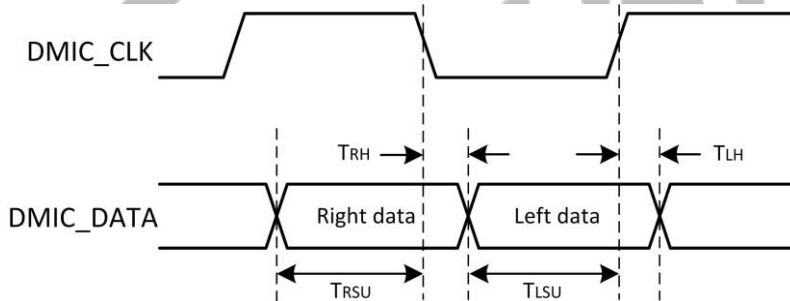

Table 5-31 DMIC Timing Constants

Parameter	Symbol	Min	Typ	Max	Unit
DMIC_DATA (Right) setup time to falling edge of DMIC_CLK	TRSU	15	-	-	ns
DMIC_DATA (Right) hold time from falling edge of DMIC_CLK	TRH	0	-	-	ns
DMIC_DATA (Left) setup time to rising edge of DMIC_CLK	TLSU	15	-	-	ns
DMIC_DATA (Left) hold time from rising edge of DMIC_CLK	TLH	0	-	-	ns

### 5.13.7 OWA AC Electrical Characteristics

Figure 5-23 OWA Timing

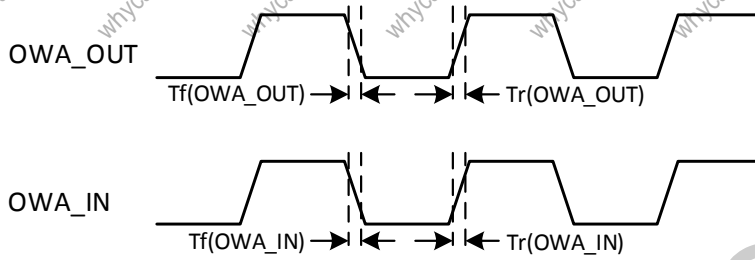

Table 5-32 OWA Timing Constants

Parameter	Symbol	Min	Typ	Max	Unit
OWA_OUT rise time	Tr(OWA_OUT)	-	-	8	ns
OWA_OUT fall time	Tf(OWA_OUT)	-	-	8	ns
OWA_IN rise time	Tr(OWA_IN)	-	-	4	ns
OWA_IN fall time	Tf(OWA_IN)	-	-	4	ns

### 5.13.8 CIR\_RX AC Electrical Characteristics

Figure 5-24 CIR\_RX Timing

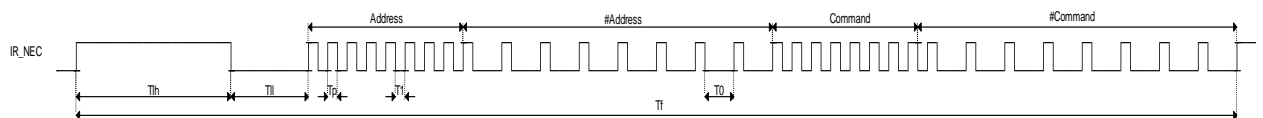

Table 5-33 CIR\_RX Timing Constants

Parameter	Symbol	Min	Typ	Max	Unit
Frame period	Tf	-	67.5	-	ms
Lead code high time	Tlh	-	9	-	ms
Lead code low time	Tll	-	4.5	-	ms
Pulse time	Tp	-	560	-	us
Logical 1 low time	T1	-	1680	-	us
Logical 0 low time	T0	-	560	-	us

## 5.14 Power-On and Power-Off Sequence

### 5.14.1 Power-On Sequence

Figure 5-25 shows an example of the power-on sequence for the D1 device. The description of the power-on sequence is as follows.

- The consequent steps in power-on sequence should not start before the previous step supplies have been stabilized within 90~110% of their nominal voltage, unless stated otherwise.
- VCC-RTC must be ramped no later than other power rails.
- VCC-IO must be ramped before VDD-SYS and VDD-CPU with a minimum delay of 2 ms.
- VCC-DRAM needs be stable before SDRAM driver initialization.
- During the entire power on sequence, the RESET signal must be held on low until all other power rails (except 24 MHz CLK) are stable for more than 64 ms.
- 24 MHz clock starts oscillating after the RESET signal is released.

Figure 5-25 Power-On Timing

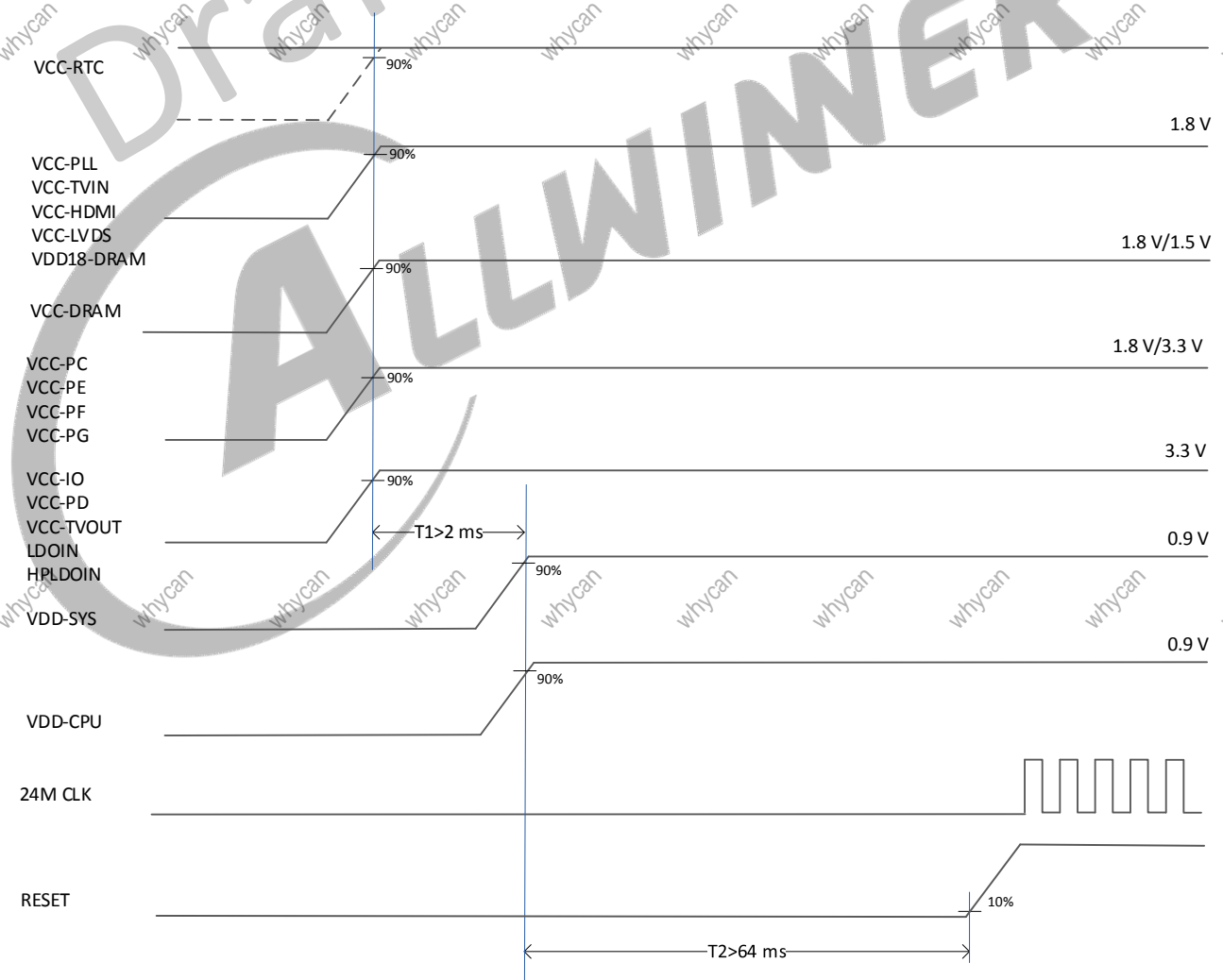

### 5.14.2 Power-Off Sequence

The power-off requirements are as follows.

- After the RESET signal goes low, the 24 MHz clock starts to stop oscillating.

**Figure 5-26 Power-Off Timing**

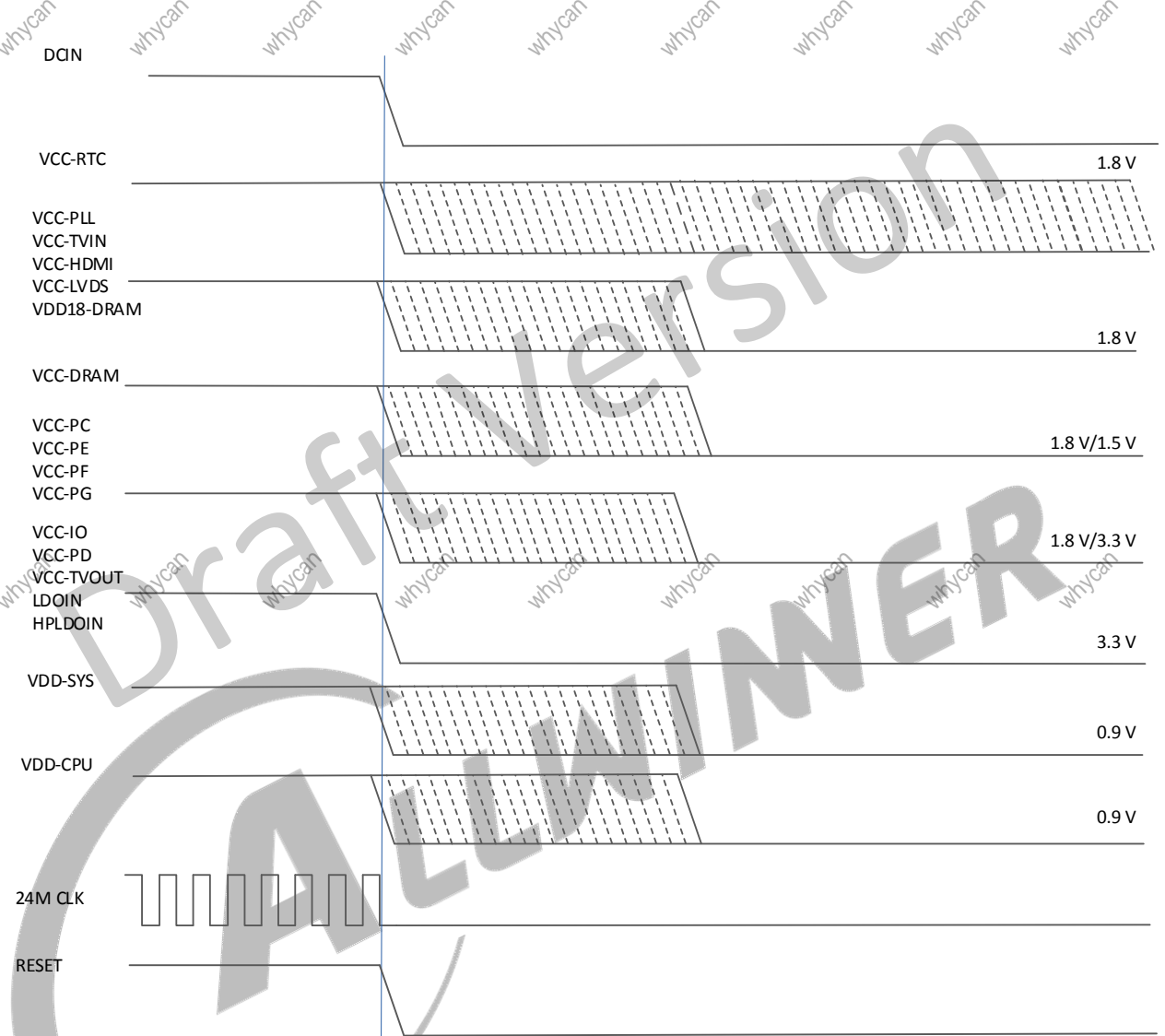

## 6 Package Thermal Characteristics

The maximum chip junction temperature ( $T_J \text{ max}$ ) must never exceed the values given in [Table 5-2 Recommended Operating Conditions](#).

The maximum chip-junction temperature  $T_J \text{ max}$ , in degrees Celsius, may be calculated using the following equation:

$$T_J \text{ max} = T_a \text{ max} + (P_D \text{ max} \times \theta_{JA})$$

Where:

$T_a \text{ max}$  is the maximum ambient temperature in °C.

$P_D \text{ max}$  is the maximum power dissipation.

$\theta_{JA}$  is the package junction-to-ambient thermal resistance, in °C/W.

°C/W = degrees Celsius per watt.

Failure to maintain a junction temperature within the range specified reduces operating lifetime, reliability, and performance, and may cause irreversible damage to the system. It is useful to calculate the exact power consumption and junction temperature to determine which the temperature will be best suited to the application. Therefore, the product should include thermal analysis and thermal design to ensure the operating junction temperature of the device is within functional limits.

The following table shows the thermal resistance characteristics of the D1. These data are based on JEDEC JESD51 standard, because the actual system design and temperature could be different from JEDEC JESD51, these simulating data are a reference only and may not represent actual use-case values, please prevail in the actual application condition test.

**Table 6-1 D1 Package Thermal Characteristics**

Symbol	Parameter	Min	Typ <sup>(1)</sup>	Max	Unit
$\theta_{JA}$	Junction-to-Ambient Thermal Resistance	-	TBD	-	°C/W
$\theta_{JB}$	Junction-to-Board Thermal Resistance	-	TBD	-	°C/W
$\theta_{JC}$	Junction-to-Case Thermal Resistance	-	TBD	-	°C/W

1. Reference document: JESD51-2 Integrated Circuits Thermal Test Method Environment Conditions – Natural Convection (Still Air). Available from [www.jedec.org](http://www.jedec.org).

# 7 Pin Assignment

## 7.1 Pin Map

For D1, LFBAG 337 balls, 13 mm x 13 mm package is offered. The following figure shows the pin map of the D1.

Figure 7-1 D1 Pin Map

	1	2	3	4	5	6	7	8	9	10	11	12	13	14	15	16	17	18	19	20
A	GND	GND	PG2	PG4		PG8		USB1-DP			TP-X2		HP-DET		GND		MIC-DET	FEL	GND	GND
B	GND	PG0	PG1	PG5	PG6	PG9	USB0-DP	USB1-DM	TVIN0	GND	TP-Y1	LRADC	GPADC1	LINEOUTR P	LINEOUTL P	LINEINL	FMINL	VRA2	VRA1	GND
C	PF1	PF0	PG3	GND	PG7	PG10	USB0-DM	GND	TVIN1	GND	TP-Y2	TP-X1	GPADC0	LINEOUTR N	LINEOUTL N	LINEINR	FMINR	AVCC	ALDO	VDD33
D	PF3	PF2	PF6	PG11	PG12	PG13	PG18		VCC-TVIN	HPVCC		HPLDOIN	HPOUTR		MICIN2N	MICIN3N	MICIN3P	AGND	MICIN1N	MICIN1P
E		PF5	PF4	VCC-PG	GND	PG14	PG17		GND-TVIN	TVIN-VRP		HPLDO	HPOUTFB		MICIN2P	MIBIAS	HBIAS	VCC- TVOUT	TVOUT0	
F	PC1	PC0	GND	VCC-PF	PC5	PG15	PG16		GND	TVIN-VRN		GND	HPOUTL		PB11	PB12	PB10	GND	HCEC	HHPD
G		PC3	PC2	VCC-PC	PC7	PC6	VDD-CPU	VDD-CPU	VDD- CPUFB	GND	GND	GND	VDD-SYS	VDD-SYS	PB8	PB9	VCC-IO	HSDA	HACL	
H	GND	GND	PC4				VDD-CPU	VDD-CPU	VDD-CPU	GND	GND	GND	VDD-SYS	VDD-SYS				GND	HTX2P	HTX2N
J		REFCLK- OUT	GND	VCC- EFUSE	VCC-PLL	GND	GND	GND	GND	GND	GND	GND	VDD-SYS	VDD-SYS	PB7	PB0	PB1	HTX1P	HTX1N	
K	DXIN	DXOUT	GND	VCC-DXO	VCC-RTC	GND	GND	GND	GND	GND	GND	GND	GND	GND	PB5	PB4	PB6	HTX0P	HTX0N	
L		X32KIN	X32KOUT				LDOA-OUT	GND	GND	GND	GND	GND	GND	GND				GND	HTXCP	HTXCN
M		RESET	GND	VCC-PE	GND	PE17	LDO-IN	GND	GND	GND	GND	GND	GND	GND	PB3	PB2	VCC-HDMI	PD19	PD18	
N	PE11	TEST	NMI	PE14	PE15	PE16	LDOB-OUT	VCC- DRAM	VCC- DRAM	VCC- DRAM	GND	GND	GND	GND	GND	PD15	PD14	GND	PD17	PD16
P		PE9	PE10				GND	VCC- DRAM	VCC- DRAM	VCC- DRAM	GND	GND	GND	VDD18- DRAM				PD13	PD12	
R	PE6	PE7	PE8	PE13	PE12	SDQ15	SDQ13		SWE	GND		SCS0	SCS1		SA13	VCC-LVDS	PD11	GND	PD9	PD8
T		PE4	PE5	SDQ14	GND	SDQ11	GND		SCAS	SCKP		SODT0	GND		SA15	VCC-PD	PD10	PD7	PD6	
U	PE1	PE2	PE3	SDQ8	SDQ10	SDQ12	SDQ9		SRAS	SCKN		SODT1	SA3		SA4	SVREF	SZQ	PD5	PD4	PD3
V	PE0	GND	GND	GND	SDQ6	GND	SDQ1	SDQ3	GND	SBA0	SA5	GND	SA0	SA2	GND	SA14	GND	PD21	PD2	PD1
W	GND	SDQM1	SDQS1P	SDQ4	SDQ7	SDQS0P	SDQ0	SDQ2	SCKE0	SBA1	SA6	SA10	SA1	SA8	SA11	SA12	GND	PD20	PD0	GND
Y	GND	GND	SDQS1N	SDQ5		SDQS0N		SDQM0	SCKE1		SBA2		SA7		SA9		SRST	PD22	GND	GND

## 7.2 Package Dimension

Figure 7-2 shows the top, bottom, and side views of D1 package dimension.

Figure 7-2 D1 Package Dimension

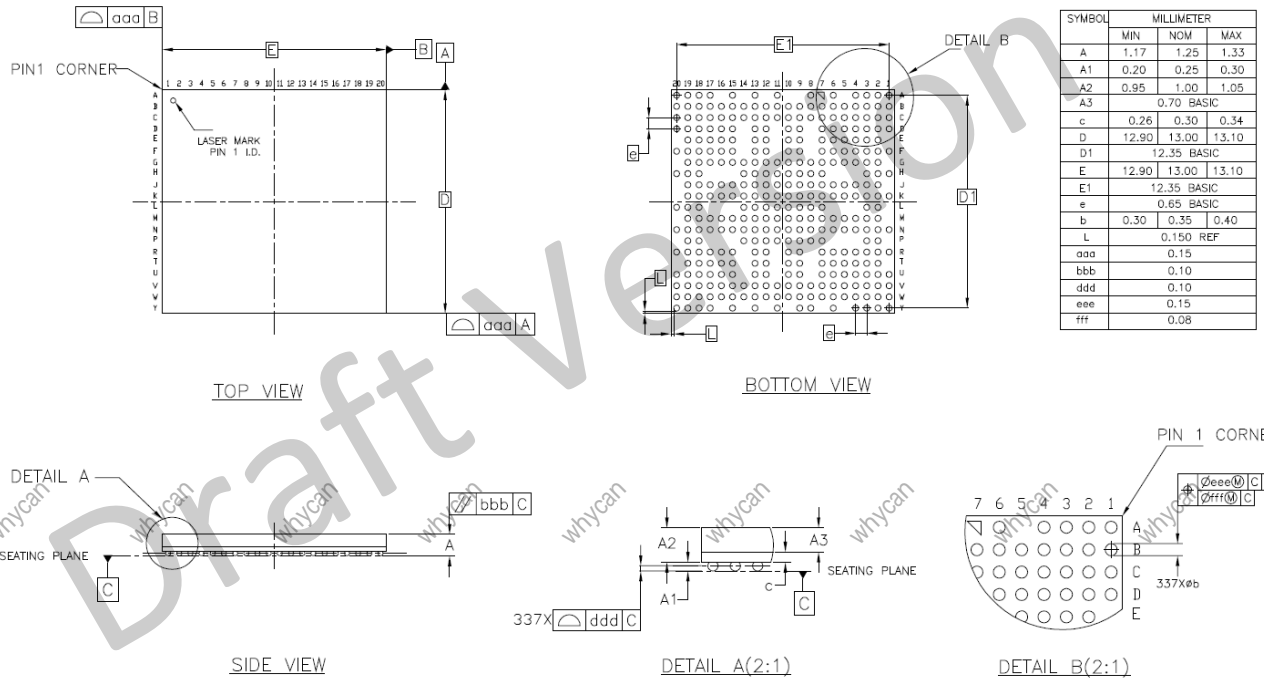



## 8 Carrier, Storage and Baking Information

### 8.1 Carrier

#### 8.1.1 Matrix Tray Information

Table 8-1 shows the D1 matrix tray carrier information.

**Table 8-1 Matrix Tray Carrier Information**

Item	Color	Size	Note
Tray	Black	315 mm x 136 mm x 7.62 mm	119 Qty/Tray
Aluminum foil bags	Silvery white	540 mm x 300 mm x 0.14 mm	Vacuum packing Including HIC and desiccant Printing: RoHS symbol
Pearl cotton cushion (Vacuum bag)	White	12 mm x 680 mm x 185 mm	
Pearl cotton cushion (The Gap between vacuum bag and inner box)	White	Left-Right: 12 mm x 180 mm x 85 mm Front-Back: 12 mm x 350 mm x 70 mm	
Inner Box	White	396 mm x 196 mm x 96 mm	Printing: RoHS symbol 10 Tray/Inner box
Carton	White	420 mm x 410 mm x 320 mm	6 Inner box/Carton

Table 8-2 shows the D1 packing quantity.

**Table 8-2 D1 Packing Quantity Information**

Sample	Size (mm)	Qty/Tray	Tray/Inner Box	Full Inner Box Qty	Inner Box/Carton	Full Carton Qty
D1	13 x 13	119	10	1190	6	7140

Figure 8-1 shows tray dimension drawing of the D1.

Figure 8-1 D1 Tray Dimension Drawing

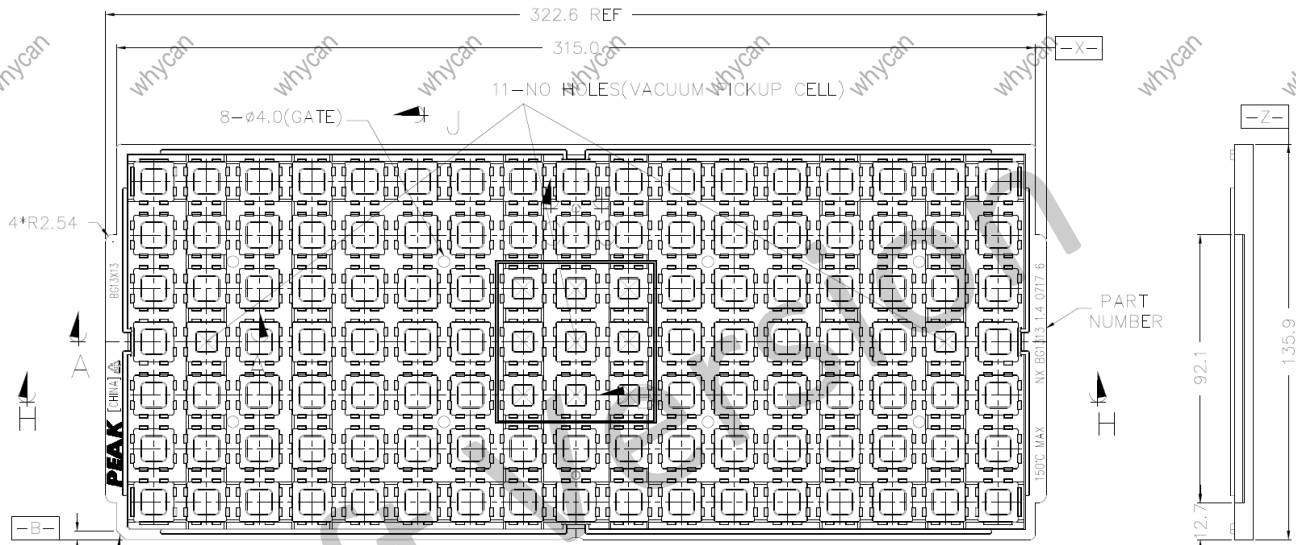

## 8.2 Storage

Reliability is affected if any condition specified in Section 8.2.2 and Section 8.2.3 has been exceeded.

### 8.2.1 Moisture Sensitivity Level (MSL)

A package's MSL indicates its ability to withstand exposure after it is removed from its shipment bag, a low MSL device sample can be exposed on the factory floor longer than a high MSL device sample. Table 8-3 defines all MSL.



**NOTE**

The D1 device samples are classified as MSL3.

Table 8-3 MSL Summary

MSL	Out-of-bag floor life	Comments
1	Unlimited	≤30°C / 85%RH
2	1 year	≤30°C / 60%RH
2a	4 weeks	≤30°C / 60%RH
3	168 hours	≤30°C / 60%RH
4	72 hours	≤30°C / 60%RH

MSL	Out-of-bag floor life	Comments
5	48 hours	≤30°C / 60%RH
5a	24 hours	≤30°C / 60%RH
6	Time on Label (TOL)	≤30°C / 60%RH

### 8.2.2 Bagged Storage Conditions

Table 8-4 defines the shelf life of the D1 device samples.

**Table 8-4 Bagged Storage Conditions**

Packing mode	Vacuum packing
Storage temperature	20–26°C
Storage humidity	40%–60%RH
Shelf life	12 months

### 8.2.3 Out-of-bag Duration

It is defined by the device MSL rating. The out-of-bag duration of the D1 is as follows.

**Table 8-5 Out-of-bag Duration**

Storage temperature	20–26°C
Storage humidity	40%–60%RH
Moisture sensitive level (MSL)	3
Floor life	168 hours

For no mention of storage rules in this document, refer to the latest *IPC/JEDEC J-STD-020C*.

## 8.3 Baking

It is not necessary to bake the D1 if the conditions specified in Section 8.2.2 and Section 8.2.3 have not been exceeded. It is necessary to bake the D1 if any condition specified in Section 8.2.2 and Section 8.2.3 has been exceeded.

It is necessary to bake the D1 if the storage humidity condition has been exceeded, we recommend that the device sample removed from its shipment bag for more than 2 days shall be baked to guarantee production.

Baking conditions: 125°C, 8 hours, nitrogen protection. Note that the baking should not exceed 1 times due to a risk of deformation.



# 9 Reflow Profile

All Allwinner chips provided for clients are lead-free RoHS-compliant products. The reflow profile recommended in this document is a lead-free reflow profile that is suitable for pure lead-free technology of lead-free solder paste. If customers need to use lead solder paste, contact Allwinner FAE.

Figure 9-1 shows the appropriate reflow profile.

**Figure 9-1 Lead-free Reflow Profile**

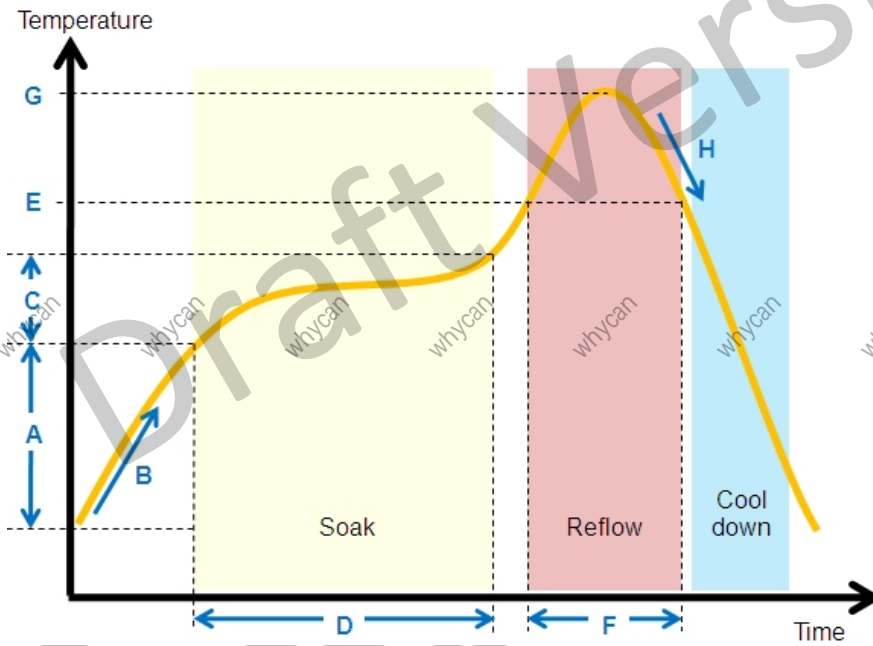

**Table 9-1 Lead-free Reflow Profile Conditions**

	QTI typical SMT reflow profile conditions(for reference only)	
	Step	Reflow condition
Environment	N2 purge reflow usage (yes/no)	Yes, N2 purge used
	If yes, O2 ppm level	O2 < 1500 ppm
A	Preheat ramp up temperature range	25°C -> 150°C
B	Preheat ramp up rate	1.5~2.5 °C/sec
C	Soak temperature range	150°C -> 190°C
D	Soak time	80~110 sec
E	Liquidus temperature	217°C
F	Time above liquidus	60~90 sec

	QTI typical SMT reflow profile conditions(for reference only)	
	Step	Reflow condition
G	Peak temperature	240–250°C
H	Cool down temperature rate	≤4°C/sec

The method of measuring the reflow soldering process is as follows.

Fix the thermocouple probe of the temperature measuring line at the connection point between the pin (solderable end) of the packaged device and the pad by using high-temperature solder wire or high-temperature tape, fix the packaged device at the pad by using high-temperature tape or other methods, and cover over the thermocouple probe. See Figure 9-2.

**Figure 9-2 Measuring the Reflow Soldering Process**

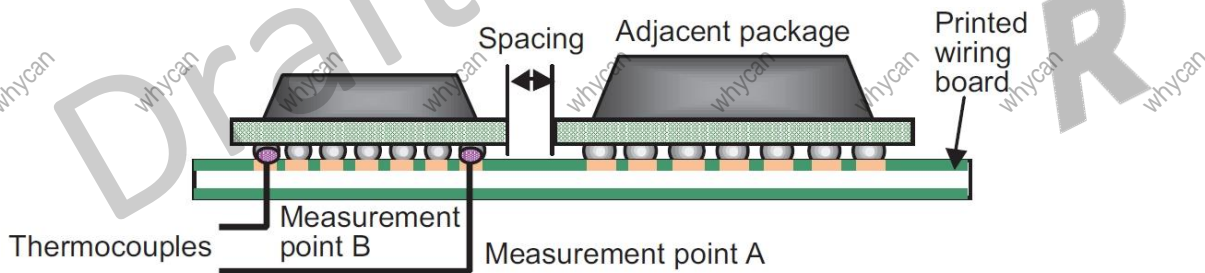

**NOTE**

To measure the temperature of the QFP-packaged chip, place the temperature probe directly at the pin.

If possible, the more accurate measuring way is to drill the packaged device, or drill the PCB, and fix the thermocouple probe through the drilled hole at the pad.

## 10 FT/QA/QC Test

### 10.1 FT Test

FT test is the finished product testing after the chip is packaged, and it is a functional test of all modules for each produced chip.

### 10.2 QA Test

QA test is a system-level sampling test for good-quality chips. According to the application level of the chip, a certain percentage of good-quality chips are selected for system-level testing to make the chip work in a typical application scenario, and judge whether the chip works normally in this scenario.

### 10.3 QC Test

QC test is a module-level sampling test for good-quality chips. According to the chip application level, a certain percentage of good-quality chips are selected for module-level functional testing to monitor whether the chip production process is normal.

# 11 Part Marking

Figure 11-1 shows the D1 marking.

Figure 11-1 D1 Marking

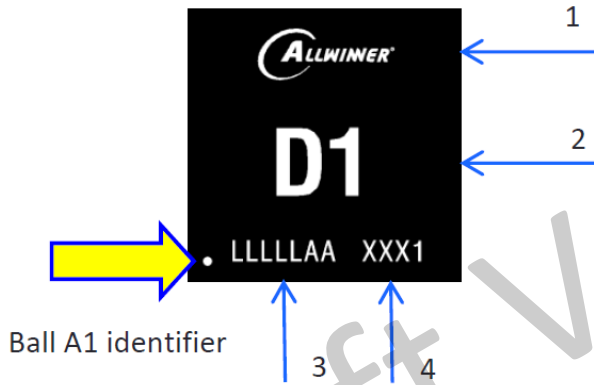

Table 11-1 describes the D1 marking definitions.

Table 11-1 D1 Marking Definitions

No.	Marking	Description	Fixed/Dynamic
1	ALLWINNER	Allwinner logo or name	Fixed
2	D1	Product name	Fixed
3	LLLLLAA	Lot number	Dynamic
4	XXX1	Date code	Dynamic



**Copyright©2021 Allwinner Technology Co.,Ltd. All Rights Reserved.**

This documentation is the original work and copyrighted property of Allwinner Technology Co.,Ltd (“Allwinner”). No part of this document may be reproduced, modify, publish or transmitted in any form or by any means without prior written consent of Allwinner.

**Trademarks and Permissions**

Allwinner and the Allwinner logo (incomplete enumeration) are trademarks of Allwinner Technology Co.,Ltd. All other trademarks, trade names, product or service names mentioned in this document are the property of their respective owners.

**Important Notice and Disclaimer**

The purchased products, services and features are stipulated by the contract made between Allwinner Technology Co.,Ltd (“Allwinner”) and the customer. All or part of the products, services and features described in this document may not be within the purchase scope or the usage scope. Please read the terms and conditions of the contract and relevant instructions carefully before using, and follow the instructions in this documentation strictly. Allwinner assumes no responsibility for the consequences of improper use (including but not limited to overvoltage, overclock, or excessive temperature).

The information in this document is provided just as a reference or typical applications, and is subject to change without notice. Every effort has been made in the preparation of this document to ensure accuracy of the contents. Allwinner is not responsible for any damage (including but not limited to indirect, incidental or special loss) or any infringement of third party rights arising from the use of this document. All statements, information, and recommendations in this document do not constitute a warranty or commitment of any kind, express or implied.

No license is granted by Allwinner herein express or implied or otherwise to any patent or intellectual property of Allwinner. Third party licences may be required to implement the solution/product. Customers shall be solely responsible to obtain all appropriately required third party licences. Allwinner shall not be liable for any licence fee or royalty due in respect of any required third party licence. Allwinner shall have no warranty, indemnity or other obligations with respect to third party licences.



Copyright © 2021 Allwinner Technology Co.,Ltd. All Rights Reserved.

Allwinner Technology Co.,Ltd.  
No.9 Technology Road 2, High-Tech Zone,  
Zhuhai, Guangdong Province, China

Contact US:  
Service@allwinnertech.com  
www.allwinnertech.com